

EN INTRODUCTION

This instruction sheet provides you with the information required to safely own and operate your product. Retain these instructions for future reference.

The product you have purchased is of the highest quality workmanship and material, and has been engineered to give you long and reliable service. This product has been carefully tested, inspected, and packaged to ensure safe delivery and operation. Please examine your item(s) carefully to ensure that no damage occurred during shipment. If damage has occurred, please contact the place of purchase. They will assist you in replacement or repair, if required.

READ THESE INSTRUCTIONS CAREFULLY BEFORE ATTEMPTING TO INSTALL, OPERATE, OR SERVICE YOUR PRODUCT. KNOW THE PRODUCT'S APPLICATION, LIMITATIONS, AND POTENTIAL HAZARDS. PROTECT YOURSELF AND OTHERS BY OBSERVING ALL SAFETY INFORMATION. FAILURE TO COMPLY WITH THESE INSTRUCTIONS COULD RESULT IN PERSONAL INJURY AND/OR PROPERTY DAMAGE!

SAFETY GUIDELINES



RISK OF ELECTRIC SHOCK—This pump is supplied with a grounding conductor and grounding-type attachment plug. To reduce the risk of electric shock, be certain that it is connected only to a properly grounded, grounding-type receptacle. As a safety measure, each electrical outlet should be checked with an Underwriters Laboratory Listed circuit analyzer. This will indicate if the power, neutral and ground wires are properly connected. If they are not, call a qualified licensed electrician.

1. **CAUTION:** To reduce the risk of electrical shock, pull plug before servicing this pump.
2. Check local electrical and building codes before installation. The installation must be in accordance with their regulations.
3. During normal operation the sump pump is immersed in water. Also, during rain storms, water may be present in the surrounding area of the pump. Caution must be used to prevent bodily injury when working near the pump:
 - a. Electrical power should be disconnected prior to touching, servicing or repairing the pump.
 - b. To minimize possible fatal electrical shock hazard, extreme care should be used when changing fuses. Do not stand in water while changing fuses or insert your finger into the fuse socket.

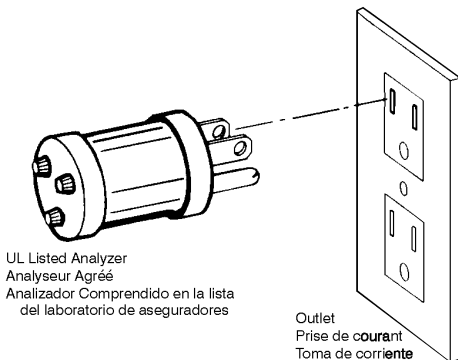

4. Do not run the pump in a dry sump. If the pump is run in a dry sump, the surface temperature of the pump will rise to a high level. This high level could cause skin burns if the pump is touched and will cause serious damage to your pump.
5. Do not oil the motor. The pump housing is sealed. A high grade dielectric oil devoid of water has been put into the motor housing at the factory. Use of other oil could cause serious electric shock and/or permanent damage to the pump.
6. This pump's motor housing is filled with a dielectric lubricant at the factory for optimum motor heat transfer and lifetime lubrication of the bearings. Use of any other lubricant could cause damage and void the warranty. This lubricant is non-toxic; however, if it escapes the motor housing, it should be removed from the surface quickly by placing newspapers or other absorbent material on the water surface to soak it up, so aquatic life is undisturbed.
7. In any installation where property damage and/or personal injury might result from an inoperative or leaking pump due to power outages, discharge line blockage, or any other reason, a backup system(s) and/or alarm should be used.

ELECTRICAL CONNECTIONS



Your sump pump is supplied with a 3-prong electrical plug (Figure 1). The third prong is to ground the pump to prevent possible electric shock hazard. Do not remove the third prong from the plug. A separate branch electrical circuit is recommended. Do not use an extension cord.

INSTALLATION

1. Clean any debris from sump pit and set pump in center of pit (Figure 2). A solid bottom will prevent clogging of the pump from sand and dirt.
2. Connect discharge piping and run it to the nearest sewer or surface outlet. Use pipe joint compound at all connections. Sump pumps can be piped to discharge into the house drainage system, to a dry well, splash block or to a storm drain, depending on local plumbing codes. The discharge pipe should be as short as possible and contain as few elbows as possible. The discharge pipe should be the same diameter as the discharge size to reduce pipe friction losses. Smaller pipe will restrict capacity and reduce pump performance. The sump pump comes with 1½" female pipe thread discharge, and 1-1/4" FNPT reducing bushing.
3. Always install a union in the discharge line, just above the sump pit to allow for easy removal of the pump for cleaning or repair.
4. In situations where the piping is long, vertical discharge is above 7 or 8 feet, or a small pit has been provided, use of a check valve is recommended to prevent backflow of water into the sump. When a check valve is used, drill a relief hole (1/8"

Figure 1

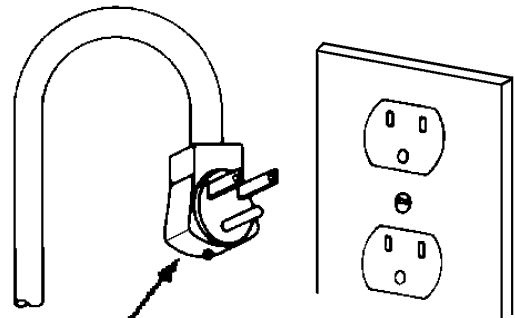
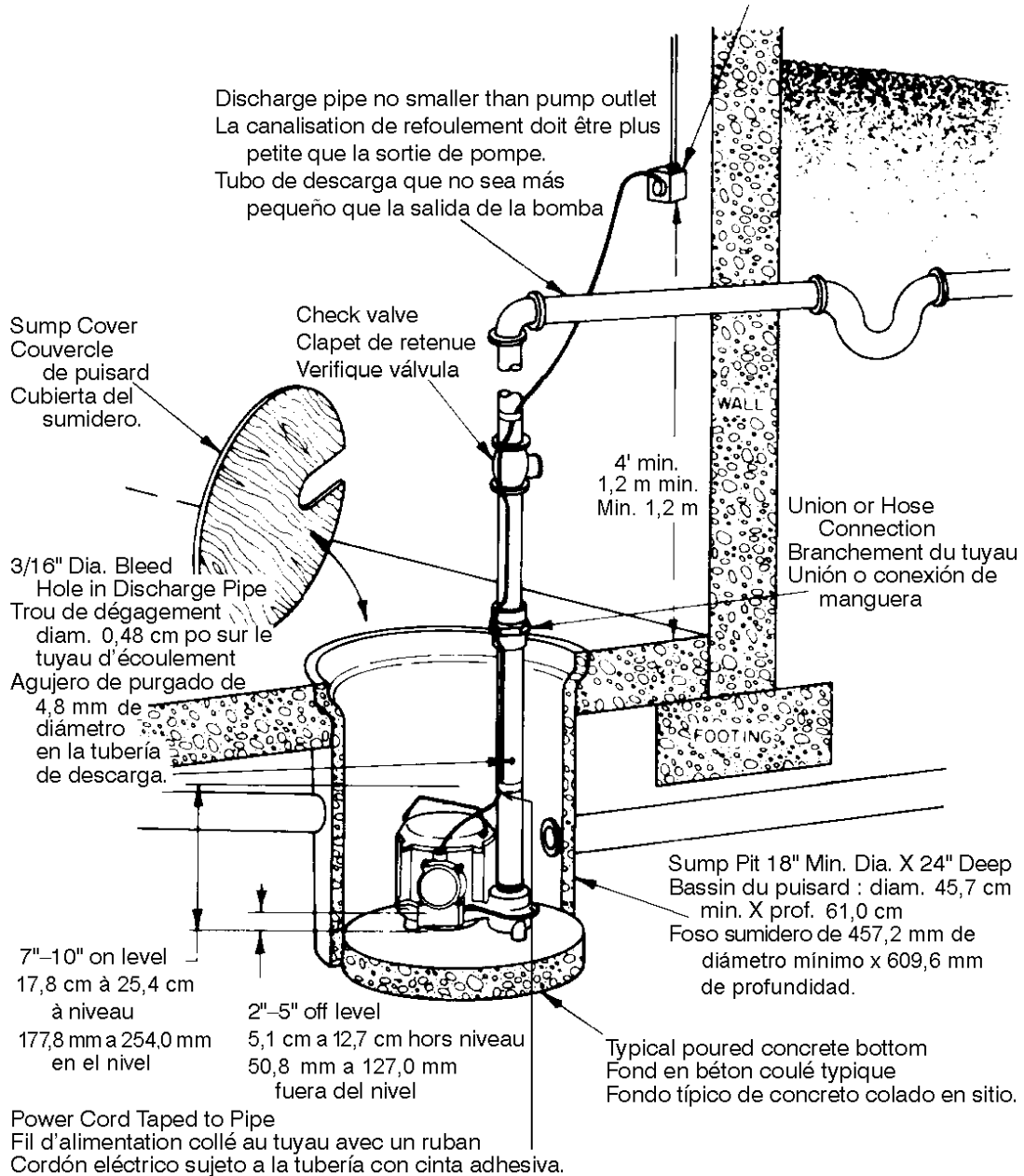

Figure 2

TYPICAL INSTALLATION INSTALLATION TYPE INSTALACION TIPICA

Separate protected and grounded service outlet 4 ft. from floor min.
Prise de courant de mise à la terre à protection séparée à une distance minimale de 1,2 m du sol
Tomacorrientes de servicio conectado a tierra y protegido separado por lo menos a 1,2 m del suelo.



or 3/16" diameter) in the discharge pipe. This hole should be located below the floor line between the pump discharge and the check valve. Unless such a relief hole is provided, the pump could "air lock" and will not pump water even though it will run.

5. Tape pump and switch cords to discharge line with electrician's tape. This will protect the cord from damage.
6. TEST THE PUMP AFTER ALL CONNECTIONS HAVE BEEN MADE. Run water into sump. Do not attempt to operate the pump without water; this will damage the seals and bearings and could result in permanent damage to the pump. Fill sump to normal "on" level and allow pump to remove to the normal "off" level (see Figure 2).

7. Place cover over sump. This cover will help prevent solid debris from filling the pit and will guard against accidental injury.

WARNING: Always disconnect the electrical power before touching the pump or discharge when water is present in the sump. Failure to do so can result in hazardous electrical shock.

FR INTRODUCTION

Cette feuille d'instructions vous fournit les informations nécessaires pour entretenir et faire fonctionner votre produit. Conserver ces directives afin de pouvoir les consulter plus tard.

Le produit que vous avez acheté a été soigneusement fabriqué avec des matériaux de la plus haute qualité et a été conçu pour durer longtemps et offrir un service fiable. Les produits sont

soigneusement testés, inspectés et emballés afin d'en assurer la sécurité de fonctionnement et une livraison en bonne condition. Vérifier attentivement le produit afin de vous assurer qu'il n'a pas été endommagé pendant le transport. S'il est endommagé, veuillez contacter l'entreprise qui vous l'a vendu. Si une réparation ou un remplacement est requis, elle vous prêtera assistance.

LIRE ATTENTIVEMENT CES DIRECTIVES AVANT DE PROCÉDER À L'INSTALLATION, À L'UTILISATION OU À L'ENTRETIEN DU PRODUIT. SE FAMILIARISER AVEC LES APPLICATIONS, LES LIMITES ET LES RISQUES POTENTIELS DU PRODUIT. ASSURER SA PROPRE PROTECTION ET CELLE DES AUTRES EN SUIVANT TOUTES LES RÈGLES DE SÉCURITÉ. LE NON-RESPECT DE CES DIRECTIVES PEUT ENTRAÎNER DES BLESSURES ET/OU DES DOMMAGES MATÉRIELS!

DIRECTIVES DE SÉCURITÉ



DANGER D'ÉLECTROCUTION—Cette pompe est équipée d'un conducteur de terre et d'une prise de terre mâle. Pour éviter tout danger d'électrocution, s'assurer que la prise est connectée à une prise de courant bipolaire plus terre. Par mesure de sécurité, chaque prise de courant devra être vérifiée par un analyseur du circuit de commande agréé par les Underwriter's Laboratories Inc. qui confirmera si la puissance, le conducteur neutre et les fils de terre sont connectés correctement. En cas de mauvaise connexion, s'adresser à un électricien qualifié.

1. **MISE EN GARDE** : Afin de réduire le risque de choc électrique, débrancher la pompe avant d'en faire l'entretien.
2. Vérifier les codes du bâtiment et de l'électricité avant l'installation. Celle-ci doit être conforme aux règlements contenus dans ces codes.
3. Durant le fonctionnement normal du système, la pompe à puisard est immergée, donc invisible. De plus, pendant les orages, il pourrait y avoir de l'eau autour de la pompe. C'est pourquoi il faut faire attention si on travaille près de celle-ci.
 - a. L'alimentation électrique doit être coupée avant de toucher la pompe, de la réparer ou d'en faire l'entretien.
 - b. Afin de réduire le risque d'électrocution, faire preuve d'une grande prudence pendant le remplacement des fusibles. Ne pas avoir les pieds dans l'eau pendant le remplacement des fusibles et ne pas insérer le doigt dans les culots de fusibles.
4. Ne pas faire fonctionner la pompe dans un puisard à sec. Une température élevée à la surface de la pompe résultera d'une telle utilisation et pourrait causer des brûlures, ainsi que de graves dommages à la pompe.
5. Ne pas lubrifier le moteur. Le boîtier de la pompe est scellé. De l'huile diélectrique de haute qualité sans eau a été mise dans le boîtier en usine. L'utilisation d'un autre type d'huile pourrait causer un choc électrique grave ou gravement endommager la pompe, ou les deux.
6. Le boîtier du moteur de cette pompe est rempli d'une huile diélectrique, pour un transfert de chaleur optimal et une lubrification durable des paliers. L'utilisation d'un autre type d'huile pourrait causer des dommages et annuler la garantie. Ce lubrifiant est non-toxique; toutefois, s'il devait s'en échapper du boîtier, retirez-le de la surface en plaçant du papier journal ou un autre matériau absorbant à la surface de l'eau. Ainsi, l'environnement aquatique ne sera pas affecté.
7. L'utilisation d'un ou de plusieurs systèmes auxiliaires et/ou d'un système d'alarme est recommandée pour toute installation potentiellement dangereuse (fuite ou défectuosité causées par une coupure de courant, un blocage du circuit de refoulement ou pour toute autre raison) pour les personnes ou la propriété.

CONNEXIONS ÉLECTRIQUES



La pompe est équipée d'une prise électrique à trois broches (Figure 1). Pour éviter les risques d'électrocution, la troisième broche relie la pompe à la terre. Ne pas retirer la troisième broche de la prise. Un circuit de dérivation séparé est recommandé. Ne pas utiliser de prolongateur.

INSTALLATION

1. Nettoyer tous, les débris qui pourraient boucher le bassin de réception et placer la pompe au centre (Figure 1). Un fond solide évitera l'obstruction le sable ou la poussière.
2. Connecter le tuyau d'écoulement et l'amener jusqu'à un égout ou une rigole. Pour toutes les connexions, utiliser un matériau d'étanchéité. Selon les règles locales de plomberie, le bassin de réception peut être relié au système d'écoulement de la maison, à un puits asséché, un stoppeur d'arroseur ou à un égout. Le tuyau d'écoulement doit être le plus court et le moins coudé possible. Afin de réduire les risques de perte par friction, son diamètre doit être le même que celui de l'écoulement. Un tuyau trop petit limitera l'étanchéité et réduira le fonctionnement. La pompe est équipée d'écoulement à filetage tuyau femelle de 1½ po, et raccord de réduction FMPT de 1-1/4" po.
3. L'installation d'un raccord au tuyau d'écoulement, juste au-dessus du bassin de réception, permettra le démontage pour le nettoyage ou une réparation éventuelle.
4. Afin d'éviter le refoulement vers le bassin de réception, l'utilisation d'une soupape d'arrêt est recommandée si le tuyau est trop long, l'écoulement vertical est au dessus de 7 à 8 pieds, ou si la fosse prévue est petite. Dans ce cas, percer dans le tuyau d'écoulement un trou de dégagement d'un diamètre de 1/8 po à 3/16 po, en-dessous du sol entre l'écoulement de la pompe et la soupape d'arrêt pour éviter qu' "un bouchon d'air" se produise qui empêcherait l'appareil de pomper même s'il fonctionnait normalement.
5. Avec du chatterton, raccorder les fils de la pompe et du commutateur au tuyau d'écoulement afin de protéger les fils.
6. **ESSAYER LA POMPE UNE FOIS TOUTES LES CONNEXIONS FAITES.** Laisser d'eau au bassin de réception. Afin d'éviter une détérioration définitive de la pompe ou des joints d'étanchéité et des supports, ne pas la faire fonctionner à vide. Remplir le bassin de réception jusqu'au niveau marqué "On" et laisser la pompe pomper jusqu'au niveau normal marqué "Off" (voir Figure 2).
7. Poser le couvercle sur le bassin de réception. Le couvercle évitera l'obstruction du bassin par des débris et les risques d'accidents corporels.

ATTENTION : Afin d'éviter tout risque d'électrocution, prendre soin de débrancher la pompe avant de la toucher ou de vider l'eau du bassin de réception.

ES INTRODUCCIÓN

Esta hoja de instrucciones le proporciona la información requerida para tener y operar de forma segura su producto. Guarde las instrucciones para referencia futura.

El producto que ha adquirido se fabrica utilizando mano de obra y materiales de la más alta calidad y ha sido diseñado para prestarle un servicio duradero y confiable. Los productos son cuidadosamente probados, inspeccionados y empacados para garantizar una entrega y operación seguras. Examine su unidad cuidadosamente para asegurarse de que no haya ocurrido

ningún daño durante el transporte. Si se ha presentado algún daño, comuníquese con el lugar de compra. Deberán darle asistencia para obtener la reparación o reemplazo, si se requiere.

LEA ESTAS INSTRUCCIONES CUIDADOSAMENTE ANTES DE INTENTAR INSTALAR, HACER FUNCIONAR O PRESTAR SERVICIO TÉCNICO A SU PRODUCTO. CONOZCA CUÁLES SON LAS APLICACIONES, LIMITACIONES Y PELIGROS POTENCIALES DE LA UNIDAD. PROTEJA A TERCEROS Y PROTÉJASE A USTED MISMO SIGUIENDO TODA LA INFORMACIÓN DE SEGURIDAD. LA FALTA DE CUMPLIMIENTO DE ESTAS INSTRUCCIONES PUEDE PRODUCIR LESIONES PERSONALES Y/O DAÑOS A LA PROPIEDAD!

NORMAS DE SEGURIDAD



PELIGRO DE CHOQUE ELÉCTRICO—Esta bomba está dotada de un cable de puesta a tierra y un enchufe accesorio de puesta a tierra. Para reducir el riesgo de choque eléctrico, cerciórese de que se encuentre conectada a un receptáculo del tipo de puesta a tierra, debidamente puesto a tierra. Como medida de seguridad, cada toma de corriente debe inspeccionarse con un analizador de circuitos comprendido en la Lista del Laboratorio de Aseguradores. Esto indicará si el hilo eléctrico, el hilo neutro y el de puesta a tierra se encuentran conectados correctamente. Si no lo están, llame a un electricista competente y autorizado.

1. **PRECAUCIÓN:** Para reducir el riesgo de choque eléctrico, desconecte la unidad de la toma de corriente antes de brindar servicio a esta bomba.
2. Consulte los códigos eléctrico y de construcción locales antes de la instalación. La instalación deberá hacerse de acuerdo con sus reglamentaciones.
3. Durante el funcionamiento normal la bomba de sumidero está inmersa en agua. Además, durante las tormentas, puede haber agua en el área circundante de la bomba. Se debe observar precaución para prevenir lesiones personales al trabajar cerca de la bomba.
 - a. Desconecte el cordón de alimentación eléctrica antes de tocar, brindar mantenimiento o reparar la bomba.
 - b. Para disminuir el riesgo de choques eléctricos posiblemente fatales, tenga sumo cuidado al cambiar los fusibles. No pise agua mientras cambia los fusibles ni introduzca el dedo en el receptáculo del fusible.
4. No haga funcionar la bomba en un sumidero seco. Si hace funcionar a la bomba en un sumidero seco, la temperatura de la superficie de la bomba acenderá hasta niveles elevados. Estos niveles elevados podrían causar quemaduras de la piel si se toca la bomba y, además, causarán daños graves a su bomba.
5. No engrase el motor. La caja de la bomba está sellada. Desde la fábrica se ha colocado un aceite dieléctrico de alto grado y repelente al agua dentro de la carcasa del motor. El uso de otro tipo de aceite podría causar daños eléctricos graves y/o daños permanentes a la bomba.
6. La caja del motor de esta bomba ha sido llenada con un lubricante dieléctrico en la fábrica para lograr una transferencia de calor óptima y la lubricación permanente de los cojinetes. El uso de cualquier otro lubricante podría causar daños y anular la garantía. Este lubricante no es tóxico; sin embargo, si se derrama de la caja del motor, se debe recoger de la superficie rápidamente colocando periódicos u otro material absorbente en la superficie del agua para limpiarlo, a fin de no perturbar la vida acuática.
7. En cualquier instalación donde puedan ocurrir daños materiales y/o lesiones personales que resulten del funcionamiento

inadecuado o de fugas en la bomba a causa de fallos en la alimentación eléctrica, bloqueo de la línea de la descarga, o cualquier otra razón, se deberá usar uno o varios sistemas de respaldo y/o alarmas.

CONEXIONES ELECTRICAS



Su bomba está dotada de un enchufe eléctrico de tres dientes (Figura 1). El tercer diente es para ponerla a tierra, con el fin de evitar el riesgo de posibles choques eléctricos. No quite el tercer diente del enchufe. Se recomienda un circuito de ramal independiente. No utilice cables de extensión.

INSTALACION

1. Limpie cualquier residuo del fondo del sumidero y coloque la bomba en el centro de éste (Figura 1). Un fondo duro evitará que la bomba se obstruya con arena y tierra.
2. Conecte la tubería de descarga, y llévela a la alcantarilla o desagüe más próximo. Utilice el compuesto para empalmes de tubos en todos los empalmes. Las bombas de sumidero pueden dotarse de tubos, para que evacúen en el sistema de drenaje de la casa, en un dique seco, un canal de desagüe o un colector de aguas lluvias, según las normas locales de cañerías. El tubo de descarga debe ser lo más corto posible, y tener el menor número posible de codos. El tubo de descarga deberá tener el mismo diámetro de la descarga, para reducir las pérdidas por fricción de los tubos. Un tubo más pequeño restringirá el rendimiento y disminuirá la capacidad de la bomba. La bomba de sumidero está dotada de un a descarga de rosca hembra de 1 pulgada y media y un casquillo reductor FNPT de una pulgada y cuarto.
3. Coloque siempre una unión en el tubo de descarga, exactamente encima del fondo del sumidero, para permitir el retiro fácil de la bomba, con el fin de limpiarla o repararla.
4. En situaciones en las cuales la tubería es larga, la descarga vertical se encuentra a más de 7 u 8 pies, o se ha suministrado un pequeño foso, se recomienda el uso de una válvula de retención, para evitar el reflujó del agua al sumidero. Cuando se utilice una válvula de retención, perforése un agujero de descompresión (de un diámetro de 1/8 ó 3/16 de pulgada) en el tubo de descarga. Este agujero deberá encontrarse debajo de la línea de la superficie del suelo, entre la descarga de la bomba y la válvula de retención. A menos que se proporcione tal agujero de descompresión, la bomba podría llenarse de burbujas de aire y no bombeará el agua, aunque sí funcionará.
5. Adhiera los cables de la bomba y el interruptor al tubo de descarga, utilizando cinta aislante. Esto protegerá los cables contra daños.
6. **PRUEBE LA BOMBA, DESPUES DE HABER HECHO TODAS LAS CONEXIONES.** Haga correr agua en el sumidero. No trate de hacer funcionar la bomba sin agua: esto dañará los obturadores y los cojinetes, y podría producir una avería permanente a la bomba. Llene el sumidero al nivel normal "de funcionamiento", y permita que la bomba saque el agua, hasta alcanzar el nivel normal de "detención". (Remítase a la Figura 2).
7. Coloque la tapa sobre el sumidero. Esta tapa evitará que los residuos sólidos llenen el fondo y protegerá contra las lesiones accidentales.

ADVERTENCIA: cuando haya agua en el sumidero, desconecte siempre la corriente eléctrica, antes de tocar la bomba o la descarga. La falta de desconexión puede causar un peligroso choque eléctrico.

REPLACEMENT PARTS LIST			MANUAL PUMPS		AUTOMATIC PUMPS		
Item No.	Part No.	Description	8-CIM	8-CBM	6-CIA	8-CIA	8-CBA
1	108101	Handle, Pump	•	•	•	•	•
2	928004	Seal Ring	•	•	•	•	•
3	108034	Pump Base	•				
3	108033	Pump Base		•			
3	108029	Pump Base			•	•	
3	108028	Pump Base					•
4	909021	Screw/Washer #10-24 x 1/2"	5		5	5	
4	909009	Screw/Washer #10-24 x 1/2"		5			5
5	108082	Screen, Intake	•	•	•	•	•
6	951547	Wiring Harness Assembly, With Tube, 8'			•		
6	951240	Wiring Harness Assembly, With Tube, 10'			•		
6	951546	Wiring Harness Assembly, With Tube, 10'				•	•
6	951563	Wiring Harness Assembly, With Tube, 25'			•	•	
6	951548	Wiring Harness Assembly, 10'	•	•			
6	951550	Wiring Harness Assembly, 25'	•	•			
7	901529	Screw, Machine #10-24 x 1/4"	•	•	•	•	•
8	921023	Washer, #10 Lock	•	•	•	•	•
9	928028	Seal Ring	•	•	•	•	•
10	108065	Housing, Manual Terminal	•	•			
11	909024	Screw/Washer #10-24 x 1-3/8"	4				
11	901501/ 921002	Screw/Washer #10-24 x 1-3/8"		4			
12	924001	O-Ring			2	2	2
13	108048	Housing, Automatic Switch			•	•	•
14	951961	Lead Wire Assembly			•	•	•
15	108202	Bracket, Switch			•	•	•
16	950323	Switch, Miniature			•	•	•
17	902404	Screw, Tap #8-18 x 3/8"			•	•	•
19	108125	Diaphragm			•	•	•
20	108055	Cover, Automatic Switch Housing			•	•	•
21	909027	Screw/Washer #10-24 x 1-3/4"			4	4	
21	909033	Screw/Washer #10-24 x 1-3/4"					4
22	599026	AD-6, Reducer Adaptor	•	•	•	•	•

Figure 3

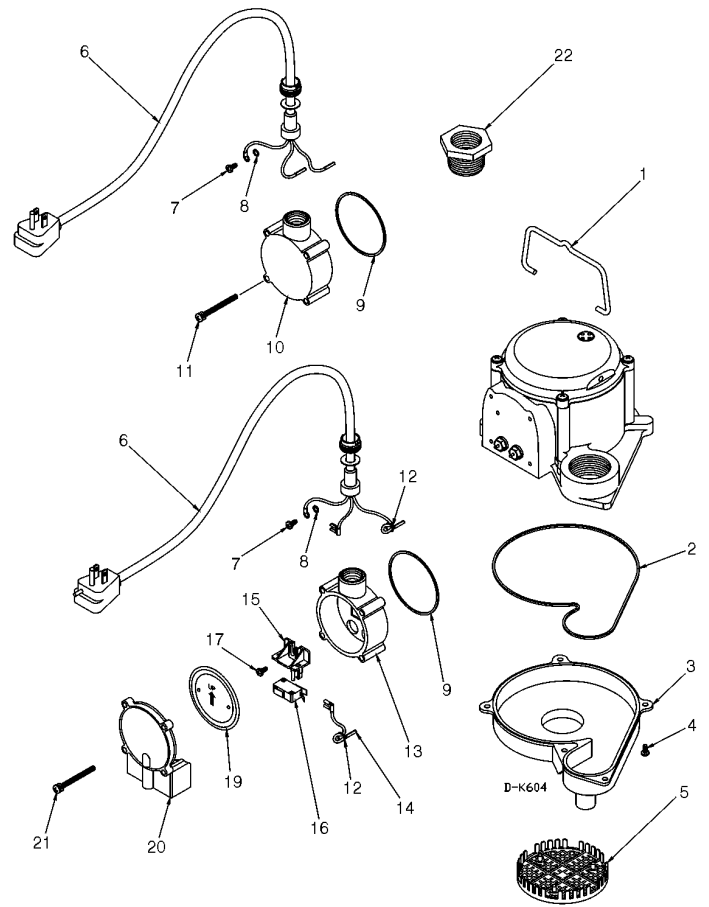
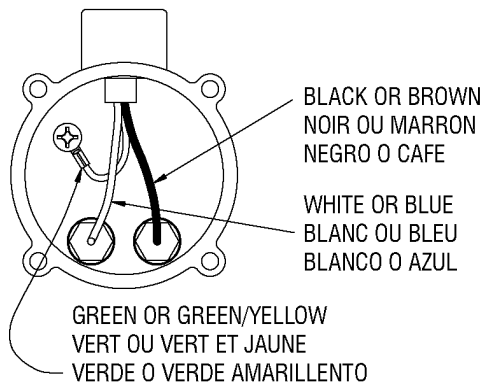
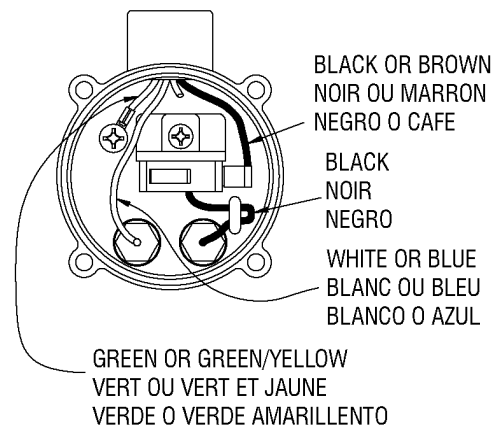

Figure 4

**MANUAL PUMP MODELS
MODÈLES DE POMPE MANUELLES
MODELOS DE BOMBAS MANUALES**



**AUTOMATIC PUMP MODELS
MODÈLES DE POMPES AUTOMATIQUES
MODELOS DE BOMBA AUTOMATICA**



**TROUBLESHOOTING INFORMATION • INFORMATION SUR LA RELÈVE DES DÉRANGEMENTS
• INFORMACION DE INVESTIGACION DE AVERIAS**

PROBLEM • FONCTIONNEMENT DÉFECTUEUX • PROBLEMA	PROBABLE CAUSES • CAUSES PROBABLES • CAUSAS PROBABLES	CORRECTIVE ACTIONS • SOLUTIONS • SOLUCION
<p>• Pump will not shut off. NOTE: Before troubleshooting automatic control, check to see that pump operates on manual control. To do this, create slight vacuum on breather tube (near plug), then close off tube with thumb, plug into wall outlet. If pump works, proceed to check switch; if not, fault is in pump or power supply.</p> <p>• Le moteur de la pompe ne s'arrête pas. Le moteur de la pompe ne s'arrête pas. REMARQUE : avant de contrôler le fonctionnement automatique, vérifiez que la pompe fonctionne en manuel. Pour cela, faire un vide dans le tube de purge (près de la prise), fermer ensuite le tuyau avec le pouce et brancher dans la prise murale. Si la pompe fonctionne, vérifiez le commutateur; si elle ne fonctionne pas, c'est la faute de la pompe ou du bloc d'alimentation.</p> <p>• La bomba no se apaga. NOTA: antes de buscar averías en el control automático, verifique si la bomba funciona con control manual. Para hacer esto, cree un ligero vacío en el tubo de aspiración (cerca del tapón). Then, cierre el tubo con el pulgar y conecte a una toma de pared. Si la bomba funciona, proceda a inspeccionar el interruptor; si no, la falla está en la bomba o el suministro de electricidad.</p>	Diaphragm switch • C'est le commutateur de diaphragme. • Interruptor del diafragma.	Replace switch • Remplacer le commutateur. • Cambie el interruptor.
	Weak or hardened rubber diaphragm • Le caoutchouc du diaphragme est faible ou durci. • Diafragma de caucho debilitado o endurecido.	Replace rubber diaphragm • Remplacer le caoutchouc du diaphragme. • Cambie el diafragma de caucho.
	Plugged vent tube • Le tuyau de purge est branché. • Tubos de aspiración ocluidos.	Clear vent tube of any obstructions • Nettoyer le tuyau de purge. • Despeje el tubo de aspiración de cualquier obstrucción.
	Dirt or sediment lodged between retainer ring and rubber diaphragm causing contacts to remain closed • Boue ou résidus logés entre le jonc et le caoutchouc du diaphragme empêchent les contacts de s'ouvrir. • La suciedad o el sedimento albergado entre el goma y anillo de retenedor el diafragma que ocasiona contactos permanecer cerró.	Clean area around rubber diaphragm • Nettoyer le contour de caoutchouc du diaphragme. • Limpie el área que rodea el diafragma de caucho.
	Pump is air locked • Poche d'air dans la pompe. • Burbujas de aire en la bomba.	Shut power off for approximately one minute, then restart. Repeat several times to clear air from pump. If system includes a check valve, a 3/16" hole should be drilled in discharge pipe approximately 2" above discharge connections. • Couper le courant pendant 1 minute environ puis recommencer. Répéter cette opération plusieurs fois pour évacuer l'air de la pompe. S'il y a une soupape d'arrêt, percer un trou de 3/16 po dans le tuyau d'écoulement, à environ 2 po au-dessus des connexions d'écoulement. • Desconnecte la electricidad durante un minuto, aproximadamente. Luego, vuélvala a conectar. Repita varias veces, para purgar el aire de la bomba. Si el sistema tiene un válvula de retención, debe perforarse un orificio de ventilación en el tubo de descarga, aproximadamente 2 pulgadas por encima de las conexiones de descarga.
	Liquid inflow matches pump capacity • Afflux de liquide correspondant au volume de la pompe. • El caudal que entra es igual a la capacidad de la bomba.	Larger pump required • Une pompe plus puissante est nécessaire. • Se requiere una bomba mayor.
<p>• Pump runs but does not discharge liquid</p> <p>• La pompe fonctionne mais il n'y a pas d'écoulement de liquide.</p> <p>• La bomba funciona, pero no descarga líquido.</p>	Defective switch • Commutateur défectueux. • Interruptor defectuoso.	Disconnect switch, check w/ohmmeter. Open—infinite resistance, closed—zero. • Débrancher le commutateur, vérifier avec un ohmmètre. Ouvert—résistance infinie, fermé—zéro. • Desconnecte el interruptor e inspecciónelo con el ohmímetro; abierto, resistencia infinita; cerrado, cero.
	Loose connection in level control wiring • Connexion des fils électriques du niveau de contrôle distendue. • Conexiones flojas en los cables del regulador de nivel.	Check control wiring • Vérifier le circuit électrique. • Inspeccione los cables del regulador.
	Check valve installed backwards • Montage à l'envers de la soupape d'arrêt • Válvula de retención montada al revés.	Check flow indicating arrow on check valve body to insure it is installed properly. • Vérifier la flèche indiquant l'écoulement pour s'assurer que la soupape d'arrêt est bien montée. • Inspeccione la flecha indicadora del flujo en el cuerpo de la válvula de retención, para cerciorarse de que se encuentre instalada correctamente.
	Check valve stuck or plugged • Soupape d'arrêt bloquée ou obstruée. • Válvula de retención atorada u ocluida.	Remove check valve and inspect for proper operation • Démontez et vérifiez la soupape d'arrêt pour un bon fonctionnement. • Quite la válvula de retención, y vérifiez que fonctionne debidamente.
	Lift too high for pump • Aspiration trop puissante pour la pompe. • Altura de impulsión excesiva para la bomba.	Check rating table. • Vérifier le tableau d'évaluation. • Estudie la tabla de capacidad.
	Inlet to impeller plugged • Arrivée de la roue à aubes obstruée. • Toma de la rueda móvil conectada.	Pull pump and clean. • Tirer la pompe pour la nettoyer. • Saque la bomba y límpiela.
<p>• Pump does not deliver rated capacity</p> <p>• La pompe ne pompe pas le volume normal.</p> <p>• La bomba no impele a su capacidad normal.</p>	Pump is air locked • Présence d'une poche d'air dans la pompe. • La bomba está llena de burbujas de aire.	Pull pump and clean. • Tirer la pompe pour la nettoyer. • Saque la bomba y límpiela.
	Lift too high for pump • Aspiration trop puissante pour la pompe. • Altura de impulsión excesiva para la bomba.	Check rated pump performance. • Vérifier les caractéristiques techniques de la pompe. • Verifique el rendimiento normal de la bomba.
	Low voltage, speed too slow. • Voltage et vitesse pas assez suffisants. • Voltaje demasiado bajo, velocidad demasiado baja.	Check for proper supply voltage to make certain it corresponds to nameplate voltage. • S'assurer que le voltage correspond bien à celui mentionné sur la plaque. • Verifique que el suministro de electricidad sea adecuado, para cerciorarse de que corresponde al voltaje indicado en la placa del fabricante.
	Impeller or discharge pipe is clogged. • Obstruction de la roue à aubes ou du tuyau d'écoulement. • La rueda móvil en el tubo de descarga está ocluida.	Pull pump and clean. Check pipe for scale or corrosion. • Tirer la pompe pour la nettoyer. Vérifier la présence de dépôts ou de corrosion dans les tuyaux. • Saque la bomba y límpiela. Inspeccione el tubo, en busca de capas de óxido o corrosión.
Impeller wear due to abrasives. • Usure de la roue à aubes due aux abrasifs. • Desgaste de la rueda móvil, debido a abrasivos.	Replace worn impeller. • Remplacer la roue à aubes usée. • Cambie la rueda móvil gastada.	

LIMITED WARRANTY

Your Little Giant product is guaranteed to be in perfect condition when it leaves our factory. It is warranted against defective materials and workmanship for a period of 24 months from date of purchase or 30 months from date of manufacture, whichever occurs first. In the absence of other suitable proof of the purchase date, the effective date of this warranty will be based upon the date of manufacture plus two years.

Any product that should fail for either of the above two reasons and is still within the warranty period will be repaired or replaced at the option of Little Giant as the sole remedy of buyer. For our customers in the CONTINENTAL UNITED STATES: Please return the defective unit, postage paid, to the factory at 301 North MacArthur Blvd., Oklahoma City, OK 73127-6616. All defective product returned under warranty will be fully inspected to determine the cause of failure before warranty is approved.

For our customers located elsewhere; it is not economical, due to duties and freight, to return the pump to the factory for inspection. Please return the defective unit to any authorized distributor or dealer with a brief written explanation of the problem. If there are no apparent signs of customer abuse, unit will be repaired or replaced. If dispute arises over replacement of the pump, the distributor or dealer is to segregate such items and hold for inspection by a representative of Little Giant Pump Company or notify factory with details of the problem for factory disposition and settlement of warranty claim.

DISCLAIMER: THE FOREGOING WARRANTY IS AN EXCLUSIVE WARRANTY IN LIEU OF ANY OTHER EXPRESS WARRANTIES. ANY IMPLIED WARRANTIES (INCLUDING, BUT NOT LIMITED TO ANY IMPLIED WARRANTY OF MERCHANTABILITY OR FITNESS FOR A PARTICULAR PURPOSE) TO THE EXTENT EITHER APPLIES TO A PUMP SHALL BE LIMITED IN DURATION TO THE PERIODS OF THE EXPRESS WARRANTIES GIVEN ABOVE.

Warranty will be **VOID** if any of the following conditions are found:

1. Sealed motor housing opened.
2. Product connected to voltage other than indicated on nameplate.
3. Cord cut off to a length less than three feet.
4. Pump allowed to operate dry (fluid supply cut off).
5. Pump used to circulate anything other than fresh water, light oils, or other mild liquids at approximately room temperature.
6. Product abuse by customer.

Any oral statements about the product made by the seller, the manufacturer, the representatives or any other parties, do not constitute warranties, shall not be relied upon by the user and are not part of the contract for sale. Seller's and manufacturer's only obligation, and buyer's only remedy, shall be the replacement and/or repair by the manufacturer of the product as described above. **NEITHER SELLER NOR THE MANUFACTURER SHALL BE LIABLE FOR ANY INJURY, LOSS OR DAMAGE, DIRECT, INCIDENTAL OR CONSEQUENTIAL (INCLUDING, BUT NOT LIMITED TO INCIDENTAL OR CONSEQUENTIAL DAMAGES FOR LOST PROFITS, LOST SALES, INJURY TO PERSON OR PROPERTY, OR ANY OTHER INCIDENTAL OR CONSEQUENTIAL LOSS), ARISING OUT OF THE USE OR THE INABILITY TO USE THE PRODUCT AND THE USER AGREES THAT NO OTHER REMEDY SHALL BE AVAILABLE TO IT.** Before using, the user shall determine the suitability of the product for the intended use, and user assumes all risk and liability whatsoever in connection therewith.

Some states and countries do not allow limitations on how long an implied warranty lasts or the exclusion or limitation of incidental or consequential damages, so the above limitations or exclusions may not apply to you. This warranty gives you specific legal rights,

and you may also have other rights which vary from state to state and country to country.

The National Electric Code (in the USA) and similar codes in other countries require a Ground Fault Circuit Interrupter (GFCI) to be installed in the branch circuit supplying fountain equipment rated above 15 volts. 115 volt GFCI's (with various cord lengths) are in stock, and we recommend each pump be used with a GFCI.

GARANTIE LIMITÉE

La présente garantit que votre pompe Little Giant est en parfaite condition à sa sortie de l'usine. La pompe est garantie contre tout défaut de matériau ou de fabrication pendant une période de 24 mois à partir de la date d'achat, ou 30 mois à partir de la date de fabrication, selon le premier terme atteint. Si aucune preuve acceptable de la date d'achat originale, la durée de cette garantie sera de deux ans à compter de la date de fabrication.

Tout produit encore garanti qui serait défectueux pour l'une des deux raisons sus-mentionnées sera réparé ou remplacé à la discrétion du fabricant. L'acheteur n'aura pas d'autre recours. Pour nos clients aux ÉTATS-UNIS (territoire continental seulement) : Veuillez retourner l'article défectueux suffisamment affranchi à l'usine à l'adresse suivante 301 North MacArthur Blvd., Oklahoma City, OK 73127-6616. Tous les produits garantis retournés feront l'objet d'une inspection détaillée afin de déterminer si la défectuosité est couverte par la garantie. Pour les clients à l'extérieur des États-Unis : étant donné les frais de douane et de transport, il n'est pas économique de retourner la pompe à l'usine pour inspection. Expédier la pompe ainsi qu'une brève description du problème à tout distributeur ou détaillant autorisé. Si elle ne présente aucun signe apparent d'une mauvaise utilisation, elle sera remplacée ou réparée. S'il y a conflit sur la nécessité de remplacer la pompe, le distributeur ou le détaillant devra garder celle-ci et, soit la fera inspecter par un représentant de Little Giant Pump Company, soit avisera l'usine du problème afin de connaître la décision de celle-ci et le règlement de la réclamation.

DÉNÉGATION : LA GARANTIE ÉNONCÉE DANS LES PRÉSENTES EST EXCLUSIVE ET REMPLACE TOUTE AUTRE GARANTIE EXPRESSE OU IMPLICITE; CELA COMPORTE, MAIS NON EXCLUSIVEMENT, TOUTE GARANTIE IMPLICITE D'APTITUDE À LA COMMERCIALISATION OU D'APTITUDE PARTICULIÈRE, POUVANT S'APPLIQUER À UNE POMPE LITTLE GIANT. DE PLUS, ELLE NE S'APPLIQUE QUE DURANT LA PÉRIODE DE COUVERTURE PRÉCISÉE CI-DEVANT.

La présente garantie sera **ANNULÉE** si:

1. Le boîtier scellé du moteur a été ouvert;
2. Le branchement à une tension autre que celle indiquée sur la plaque du fabricant a été effectué;
3. Le fil d'alimentation a été coupé à une longueur inférieure à 0,91 m (trois pieds);
4. La pompe a tourné à vide (l'alimentation en liquide a été coupée);
5. La pompe a été utilisée pour faire circuler des liquides autres que de l'eau fraîche, des huiles légères ou d'autres liquides non corrosifs et ce, à la température ambiante;
6. La pompe a été mal utilisée.

Toute déclaration sur la pompe faite oralement par le vendeur, le fabricant, le représentant ou par toute autre partie ne constitue pas une garantie et, par conséquent, ne peut servir à l'utilisateur. De plus, une telle déclaration ne peut, en aucun cas, faire partie du contrat de vente. L'unique obligation du vendeur et du fabricant, et l'unique recours de l'acheteur, est le remplacement ou la réparation de la pompe selon les modalités décrites précédemment. **NI LE VENDEUR NI LE FABRICANT NE PEUVENT ÊTRE TENUS RESPONSABLES DE TOUTE BLESSURE, TOUTE PERTE, OU TOUT DOMMAGE DIRECT, INDIRECT OU ACCESSOIRE (INCLUANT, MAIS**

NON EXCLUSIVEMENT, LES VENTES OU PROFITS PERDUS, LES ATTEINTES AUX PERSONNES OU À LA PROPRIÉTÉ OU TOUTE AUTRE PERTE INDIRECTE OU ACCESSOIRE) RÉSULTANT DE L'UTILISATION OU DE L'INCAPACITÉ D'UTILISATION DE LA POMPE, ET L'ACHETEUR CONVIENT QU'IL NE DISPOSE D'AUCUN AUTRE RECOURS. L'acheteur doit s'assurer que la pompe convient à l'usage projeté; il assume aussi tout risque et toute responsabilité relativement à cet usage.

Certaines juridictions ne permettent pas la limitation de la durée d'une garantie ou l'exclusion ou la limitation de responsabilité pour des dommages indirects ou accessoires. Par conséquent, il est possible que la limitation ou l'exclusion indiquée précédemment puisse ne pas être applicable. Cette garantie vous donne des droits particuliers et peut-être d'autres, dépendamment des juridictions en vigueur.

Le code national de l'électricité et autres codes semblables d'autres pays exigent l'installation d'un interrupteur avec mise à la terre (GFI) sur le circuit d'alimentation de la fontaine pour toute installation dont la tension est supérieure à 15 volts. Nous offrons de tels interrupteurs (avec différentes longueurs de fil) et nous recommandons que chaque pompe soit reliée à un interrupteur de ce type.

GARANTIA LIMITADA

El producto que Little Giant le ofrece está garantizado a estar en perfectas condiciones al momento de salir de la fábrica. El producto está garantizado contra materiales y fabricación defectuosa por un período de 24 meses a partir de la fecha de compra o 30 meses a partir de la fecha de fabricación, lo que ocurra primero. En ausencia de otra prueba apropiada de la fecha de compra, la fecha de vigencia de esta garantía se basará en la fecha de manufactura, más dos años.

Cualquier producto que falle por alguna de las dos razones anteriores y que esté dentro del período de garantía será reparado o reemplazado a opción de Little Giant y éste será el único remedio del comprador. Para nuestros clientes en los ESTADOS UNIDOS CONTINENTALES: Por favor, devolver la unidad defectuosa, con el porte pagado, a la fábrica en 301 North MacArthur Blvd., Oklahoma City, OK 73127-6616. Todo producto defectuoso devuelto bajo la garantía será cuidadosamente inspeccionado para determinar la causa de la falla antes de aprobar la garantía. Para nuestros clientes ubicados en otros lugares; no es económico devolver la bomba a la fábrica para que ésta sea inspeccionada, debido a los impuestos y al flete. Por favor, devuelva la unidad defectuosa a cualquier distribuidor o vendedor autorizado con una breve explicación por escrito del problema. Si no existen señas aparentes de abuso por parte del cliente, la unidad será reemplazada o reparada. Si se produce una disputa sobre el reemplazo de la bomba, el distribuidor o vendedor debe separar los artículos y retenerlos para que sean inspeccionados por un representante de Little Giant Pump Company o avisarle a la fábrica de los detalles del problema para que la fábrica disponga de las acciones necesarias y resuelva el reclamo de la garantía.

DESAUTORIZACION: LA GARANTIA ANTERIOR ES UNA GARANTIA EXCLUSIVA EN LUGAR DE CUALQUIER OTRA

GARANTIA EXPRESA. CUALQUIER GARANTIA IMPLICADA (INCLUYENDO PERO NO LIMITADO A CUALQUIER GARANTIA IMPLICADA DE COMERCIALIZACION O APTITUD PARA PROPOSITO PARTICULAR) EN LA MEDIDA EN QUE SE PUEDA APLICAR A UNA BOMBA, QUEDARA LIMITADA EN DURACION A LOS PERIODOS DE GARANTIAS PROPORCIONADOS ANTERIORMENTE.

La garantía será declarada **NULA** si se encuentran cualesquiera de las siguientes condiciones:

1. El alojamiento sellado del motor abierto.
2. El producto conectado a un voltaje que no es el indicado en la placa principal.
3. El cable cortado a menos de tres pies (0,91 m.).
4. Se permitió que la bomba opere en seco (envío de fluido cortado).
5. La bomba empleada para hacer circular cualquier otra sustancia que no sea agua fresca, aceites livianos u otros líquidos livianos aproximadamente a temperatura ambiente.
6. Abuso del producto por parte del cliente.

Cualquier declaración oral acerca del producto hecha por el vendedor, fabricante, representantes o cualquiera de las partes, no constituyen garantías, el usuario no debe confiarse de ellas, y no forman parte del contrato de compra-venta. La única obligación del vendedor y del fabricante y el único remedio para el comprador, será la reposición y/o reparación del producto por parte del fabricante bajo las condiciones descritas anteriormente. NI EL VENDEDOR NI EL FABRICANTE SE HACEN RESPONSABLES DE NINGUNA LESION, PERDIDA O DAÑO, DIRECTO, INCIDENTAL O CONSECUENTE (INCLUYENDO, PERO SIN LIMITARSE A, DAÑOS INCIDENTALES O CONSECUENTES DEBIDO A GANANCIAS PERDIDAS, VENTAS PERDIDAS, DAÑOS A PERSONAS O PROPIEDADES O CUALQUIER OTRA PERDIDA INCIDENTAL O CONSECUENTE), QUE RESULTE DEL USO O DE LA IMPOSIBILIDAD DEL USO DEL PRODUCTO, Y EL COMPRADOR ACUERDA QUE NO EXISTE OTRO REMEDIO DISPONIBLE PARA EL. Antes de usar, el usuario debe determinar si el producto se adapta al uso deseado, y el usuario asume todos los riesgos y responsabilidades en relación a ello.

Algunos estados y países no permiten limitaciones sobre la duración de una garantía implícita o la exclusión o limitación de daños incidentales o consecuentes, de manera que las limitaciones o exclusiones anteriores podrían no tener aplicación en su caso. Esta garantía le da derechos legales específicos, y usted podría disponer también de otros derechos que varían de un estado a otro y de un país a otro.

El Código Eléctrico Nacional (en los Estados Unidos) y códigos similares en otros países requieren un Interruptor de circuito de falla de conexión a tierra (GFCI) para ser instalado en el circuito secundario que suministra equipo de fuente calibrado por encima de 15 voltios. En el almacén se encuentran GFCI de 115 voltios (con varias longitudes de cable), y recomendamos que cada bomba sea usada con un GFCI.

For parts or repair, please contact1-888-572-9933
For technical assistance, please contact1-888-956-0000

Pour des parties ou la réparation,
entrez s'il vous plaît en contact1-888-572-9933
Pour l'aide technique, entrez s'il vous plaît en contact1-888-956-0000

Para partes o la reparación,
por favor póngase en contacto1-888-572-9933
Para la ayuda técnica, por favor póngase en contacto1-888-956-0000

www.LittleGiantPump.com
CustomerService-WTS@fele.com

LittleGIANT®

Sump Pump Battery Backup Systems

Owner's Manual





Franklin Electric

Before Getting Started

Read and follow safety instructions. Refer to product data plate(s) for additional operating instructions and specifications.

This is the safety alert symbol. When you see this  symbol on your pump or in this manual, look for one of the following signal words and be alert to the potential for personal injury or property damage if ignored:

 **DANGER** warns about hazards that will cause serious personal injury, death or major property damage if ignored.

 **WARNING** warns about hazards that can cause serious personal injury, death or major property damage if ignored.

 **CAUTION** warns about hazards that will or can cause minor personal injury or major property damage if ignored.

 **NOTICE** indicates special instructions which are important but not related to hazards. Carefully read and follow all safety instructions in this manual and on pump.



WARNING

 **WARNING RISK OF ELECTRIC SHOCK** - This pump is supplied with a grounding conductor and grounding type attachment plug. To reduce risk of electric shock, be certain that it is connected only to a properly grounded, grounding-type receptacle. Disconnect power before working on or around the sump pump or battery backup system.

This equipment should be installed by technically qualified personnel. Failure to install in compliance with national, local electrical, and within Franklin Electric recommendations may result in electrical shock or fire hazard, unsatisfactory performance, or equipment failure. Installation information is available through pump manufacturers and distributors, or directly from Franklin Electric at our toll free number 1-800-701-7894.

This equipment must not be used by children or persons with reduced physical, sensory or mental abilities, or lacking in experience and expertise, unless supervised or instructed. Children may not use the equipment, nor may they play with the equipment or in the immediate vicinity.

If the power cord is damaged, it must only be replaced by qualified personnel.

- Keep work area clean, well-lit, and uncluttered.
- Keep safety labels clean and in good condition.
- Wear safety glasses while installing or performing maintenance on pump.
- Do not run pump dry. Fill pump with water before starting or pump will be damaged.
- Make sure all **ELECTRICAL POWER IS OFF** before connecting any electrical wires. Wire sump pump system for correct voltages. Follow all pump wiring instructions provided in the “Wiring” section of this manual.

CAUTION

- Keep work area clean, well-lit, and uncluttered.
- Keep safety labels clean and in good condition.
- Wear safety glasses while installing or performing maintenance on pump.
- Do not run pump dry. Fill pump with water before starting or pump will be damaged.
- Make sure all **ELECTRICAL POWER IS OFF** before connecting any electrical wires. Wire sump pump system for correct voltages. Follow all pump wiring instructions provided in the “System Wiring Diagram” and “Electrical Connections” sections of this manual.

Table of Contents

Getting Started	4
Specifications	5
Pump Performance Curves.....	7
Installation of Backup System on Common Discharge (Models SPBS-10HF and SPBS-12HF).....	8
Installation of Backup System on Separate Discharge (Models SPBS-10HF and SPBS-12HF).	11
Installation of Pre-assembled Backup System on Common Discharge (Models SPBS-10HF-6 and SPBS-12HF-10)	14
Charger/Controller Unit Installation.....	15
Electrical Connections.....	17
System Wiring Diagram	17
Charger/Controller Unit Operation	18
Sump System Operation Testing	19
System Maintenance.....	20
System Troubleshooting	21
Limited Warranty	22

Getting Started

This owner's manual provides you with the information required to safely own and operate your Little Giant battery backup system. Retain these instructions for future reference. The Little Giant battery backup system you have purchased is of the highest quality workmanship and material, and has been engineered to give you long and reliable service. Little Giant pumps are carefully tested, inspected, and packaged to ensure safe delivery and operation. Please examine your pump carefully to ensure that no damage occurred during shipment. If damage has occurred, please contact the place of purchase. They will assist you in replacement or repair, if required.

⚠ WARNING READ THESE INSTRUCTIONS CAREFULLY BEFORE ATTEMPTING TO INSTALL, OPERATE, OR SERVICE YOUR LITTLE GIANT PUMP. KNOW THE PUMP'S APPLICATION, LIMITATIONS, AND POTENTIAL HAZARDS. PROTECT YOURSELF AND OTHERS BY OBSERVING ALL SAFETY INFORMATION. FAILURE TO COMPLY WITH THESE INSTRUCTIONS COULD RESULT IN PERSONAL INJURY AND/OR PROPERTY DAMAGE!

Description

The battery backup system is designed as a backup to work in conjunction with a primary sump pump providing operation during temporary power outages or if the primary pump fails to function due to a blown fuse, tripped circuit breaker, defective switch, debris clogging the primary pump, or for any other reason.



⚠ DANGER Do not use to pump flammable or explosive fluids such as gasoline, fuel oil, kerosene, etc. Do not use in explosive atmospheres. Pump should only be used with liquids compatible with pump component materials. Do not handle pump or Charger/Controller Unit with wet hands or when standing on a wet or damp surface, or in water.

⚠ WARNING To reduce risk of electric shock which can result in personal injury, death or major property damage if ignored, be certain that the 115 VAC pump and the Charger/Controller Unit are connected to outlets protected by ground fault circuit interrupters (GFCI). Comply with all national and local electrical and plumbing codes when installing this unit. Do not use the same 115 VAC outlet for primary pump and Battery Charger/Controller Unit. Do not use extension cord.

⚠ WARNING A spark near the battery may cause an explosion. Always unplug Charger/Controller Unit prior to making connections to or disconnections from the battery. Take care to prevent accidental shorting across battery terminals during handling. Do not leave battery uncovered. Attach or strap cover security on battery box when completing installation.

⚠ CAUTION The battery required to operate this unit contains acid and proper precautions must be taken when handling. Refer to battery manufacturer's safety guidelines. Failure to use proper personal protective equipment or electrical caution can result in hazards that will or can cause personal injury or major property damage if ignored.

⚠ CAUTION If a Carbon Monoxide (CO) sensor is installed near the battery backup system, battery, or Charger/Controller Unit, nuisance or false alarms could result. CO detectors should be a minimum of 15 feet from the systems. Refer to the manufacturer of CO detector for additional instructions or information.

⚠ NOTICE The Charger/Controller Unit emits an audible alarm when running the 12 VDC backup pump. An additional (not supplied in this kit) audible high water alarm on the sump system is recommended in any installations where property damage and/or personal injury might result from an inoperative sump system due to long term power outages, discharge line blockage, or any other reason.

Specifications

Item Number	Model Number								
506406	SPBS-10HF								
Charging Unit	Model Number	Volts	Hz	Max Input Amps at 115 VAC	Max Output Amps at 12 VDC	Watts	Cord (ft)	Weight (lb)	Battery Leads (ft)
Item Number									
106469	1210HF	115 VAC	60	3	10	345	6	5	6
Backup Pump Switch	Model Number	Volts	Hz	Switch On Level	Switch Off Level	Watts	Cord (ft)	Weight (lb)	Battery Leads (ft)
Item Number									
105601	RS-12	12 VDC	-	13.5"	9"	-	9	0.5	-
Backup Pump	Model Number	Volts	Hz	Amps		Watts	Cord (ft)	Weight (lb)	Battery Leads (ft)
Item Number				FLA	Start				
106963	2500	12 VDC	-	14	32	168	6	6	-

Item Number	Model Number								
506407	SPBS-12HF								
Charging Unit	Model Number	Volts	Hz	Max Input Amps at 115 VAC	Max Output Amps at 12 VDC	Watts	Cord (ft)	Weight (lb)	Battery Leads (ft)
Item Number									
106486	1212HF	115 VAC	60	3	12	345	6	5	6
Backup Pump Switch	Model Number	Volts	Hz	Switch On Level	Switch Off Level	Watts	Cord (ft)	Weight (lb)	Battery Leads (ft)
Item Number									
105601	RS-12	12 VDC	-	13.5"	9"	-	9	0.5	-
Backup Pump	Model Number	Volts	Hz	Amps		Watts	Cord (ft)	Weight (lb)	Battery Leads (ft)
Item Number				FLA	Start				
106961	3360	12 VDC	-	15	32	180	6	6	-

Specifications

Item Number	Model Number								
506411	SPBS-10HF-6								
Charging Unit									
Item Number	Model Number	Volts	Hz	Max Input Amps at 115 VAC	Max Output Amps at 12 VDC	Watts	Cord (ft)	Weight (lb)	Battery Leads (ft)
106469	1210HF	115 VAC	60	3	10	345	6	5	6
Backup Pump		AMPS							
Item Number	Model Number	Volts	Hz	FLA	Start	Watts	Cord (ft)	Weight (lb)	Battery Leads (ft)
106963	2500	12 VDC	-	14	32	168	6	6	-
Backup Pump Switch									
Item Number	Model Number	Volts	Hz	Switch On Level	Switch Off Level	Watts	Cord (ft)	Weight (lb)	Battery Leads (ft)
105601	RS-12	12 VDC	-	13.5"	9"	-	9	0.5	-
Primary Pump									
Item Number	Model Number	Volts	Hz	Horsepower (HP)	Amps - FLA	Watts	Cord (ft)	Weight (lb)	Battery Leads (ft)
506807	6EC-CIA-SFS	115 VAC	60	1/3	5	600	10	30	-

Item Number	Model Number								
506410	SPBS-12HF-10								
Charging Unit									
Item Number	Model Number	Volts	Hz	Max Input Amps at 115 VAC	Max Output Amps at 12 VDC	Watts	Cord (ft)	Weight (lb)	Battery Leads (ft)
106486	1212HF	115 VAC	60	3	12	345	6	5	6
Backup Pump		Amps							
Item Number	Model Number	Volts	Hz	FLA	Start	Watts	Cord (ft)	Weight (lb)	Battery Leads (ft)
106961	3360	12 VDC	-	15	32	180	6	6	-
Backup Pump Switch									
Item Number	Model Number	Volts	Hz	Switch On Level	Switch Off Level	Watts	Cord (ft)	Weight (lb)	Battery Leads (ft)
105601	RS-12	12 VDC	-	13.5"	9"	-	9	0.5	-
Primary Pump									
Item Number	Model Number	Volts	Hz	Hz	Amps - FLA	Watts	Cord (ft)	Weight (lb)	Battery Leads (ft)
510803	10EC-CIA-SFS	115 VAC	60	1/2	6.5	750	10	26	-

Pump Performance Curves

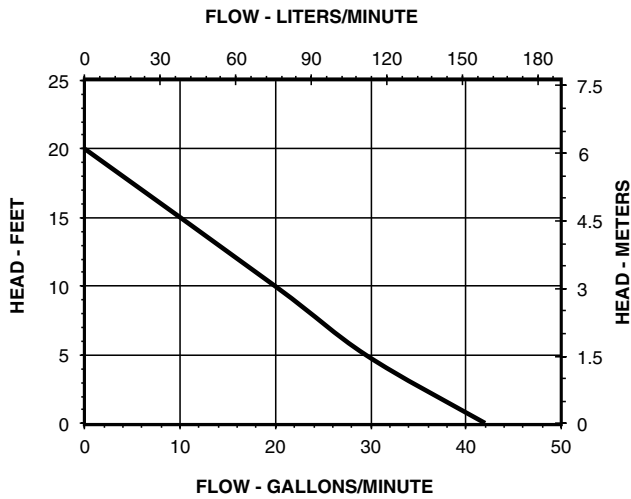

2500 12 VDC (106963)

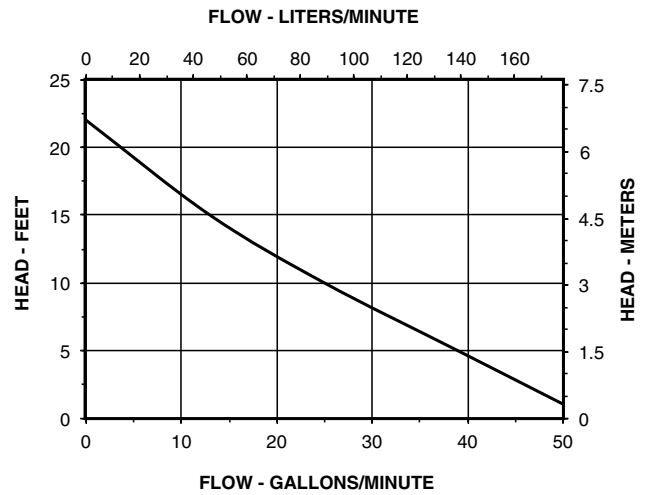

3360 12 VDC (106961)

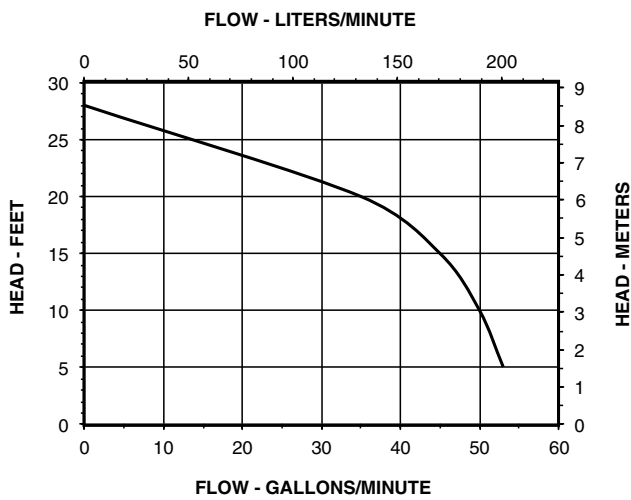

6EC-CIA-SFS (506807)

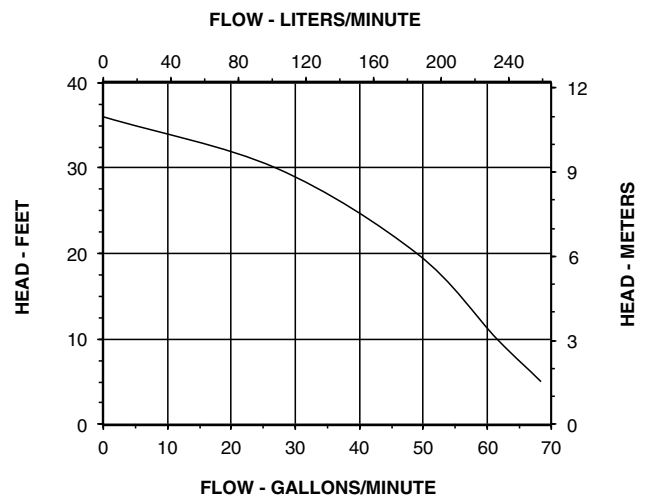

10EC-CIA-SFS (510803)

Installation of a Backup System on a Common Discharge

(For 12 VDC Backup Systems SPBS-10HF and SPBS-12HF which do not include a 115 V primary sump pump assembly)



WARNING Comply with all national and local electrical and plumbing codes when installing this unit. Disconnect power from all electrical equipment housed within the sump system before working on or around the sump pump or battery backup system beginning with 115 VAC powered pumps, level switches, and charger controllers; followed by DC powered items. Includes all items such as pumps, level control switches, Charger/Controller Unit, and battery systems.

Included in the SPBS-10HF and SPBS-12HF Kits:

1. Battery charger/controller
2. Battery case (battery not included)
3. (1) 1-1/2" street elbow near 12 VDC pump
4. Flexible coupling from 12 VDC pump discharge
5. Check valve for 12 VDC pump
6. Switch to control 12 VDC pump
7. 12 VDC backup pump
8. (4) Cable ties

Customer required to purchase separately:

1. 12 VDC deep cycle battery – BCI Group 27, rated 85 – 140Ah, lead-acid or AGM
2. 115 VAC primary pump. Little Giant's 6EC-CIA-SFS or 10EC-CIA-SFS automatic pump is recommended
3. Check valve for 115 VAC pump
4. 1-1/2" pipe as needed
5. 1-1/2" DWV street elbow H-SPG 45 degree
6. 1-1/2" DWV wye
7. Fittings – as required

Backup System on a Common Discharge

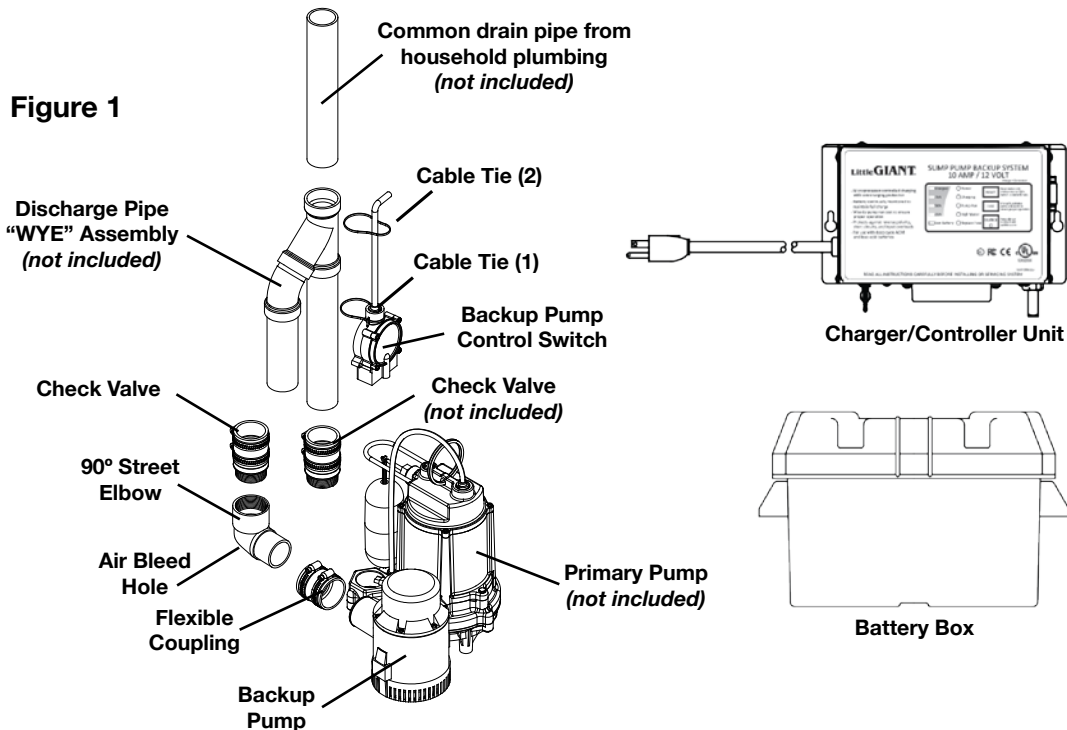

⚠ CAUTION Reduction of plumbing sizes from what is used for the discharges of the primary 115 VAC pump and 12 VDC pump can result in system underperformance. Discharge piping that is of insufficient size can result in premature pump and/or system operation failure.

Figure 2

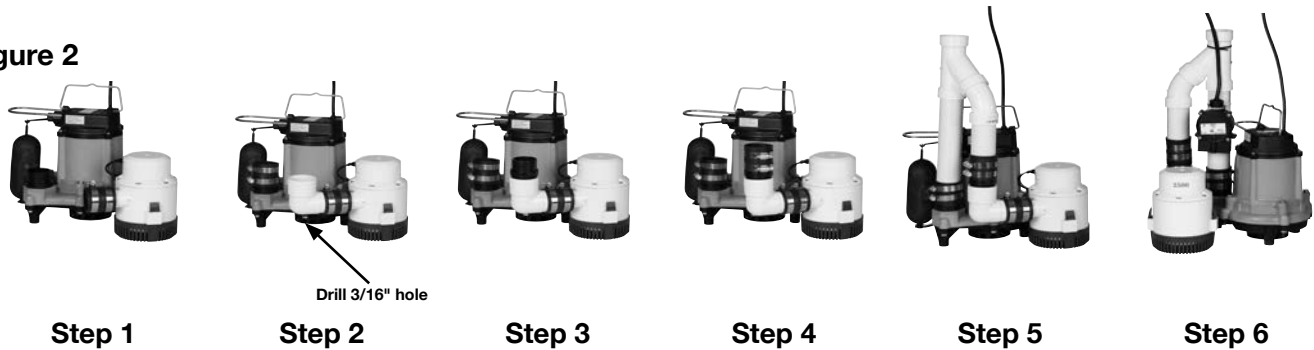

⚠ NOTICE: Do not glue any parts until the entire assembly, including primary pump, has been dry-assembled to verify fits. Fitting plumbing and routing wiring away from control floats will be much easier on a bench rather than working down inside a sump pit. (Fig. 2)

Step 1

- Install flexible coupling onto 12 VDC pump discharge.
- Position two hose clamps in the grooved recesses of flexible coupling installed on the 12 VDC pump.
- Tighten the flexible coupling's first hose clamp connection to securely fasten it to the 12 VDC pump discharge.
- Leave the hose clamp on the opposite end loose for the next plumbing piece.

Step 2

- A 3/16" diameter air bleed hole has been drilled in the 90° street elbow that is provided with the kit. (**NOTICE:** Air bleed hole must be located between the check valve and the 12 VDC pump to prevent the 12 VDC pump from air-locking.) The bleed hole is located so that the water flow through it will be at a downward angle to prevent splashing from the basin/pit.
- Slip 90° street elbow into the flexible coupling attached to the 12 VDC pump discharge, and tighten the hose clamp to secure elbow to the 12 VDC pump's discharge. (When properly installed the threaded elbow connection of the 90° street elbow should be facing straight up toward the top of the sump pit).

Step 3

⚠ NOTICE: A check valve is supplied and required for the backup pump's discharge plumbing. This check valve must be installed in the discharge plumbing between the backup pump and the wye connection joining the backup pump's discharge to that of the primary pump's discharge.

- Apply PTFE tape to male threads of provided check valve.
- Thread PTFE taped end of check valve into 90° elbow.

Step 4

- Position two hose clamps in the grooved recesses of the flexible coupling on the check valve installed in the elbow.
- Tighten the lower hose clamp to secure the flexible coupling to the check valve body.
- Loosely tighten the upper hose clamp so it does not fall off. This clamp will be used to secure the check valve to the discharge pipe "wye" assembly.

Step 5

- Review the discharge plumbing of the 115 VAC primary pump.

⚠ NOTICE: A customer-supplied check valve is required in the discharge plumbing of the 115 VAC primary sump pump.

- This check valve must be installed in the discharge plumbing between the primary pump and the wye connection joining the backup pump's discharge to that of the primary pump's discharge. A 3/16" diameter air bleed hole must be located between the check valve and the 115 VAC pump to prevent the 115 VAC pump from air-locking. Locate the bleed hole so that the water flow through it will be at a downward angle to prevent splashing from the basin/pit.
- The 1-1/2" PVC pipe used in making the discharge pipe "wye" assembly must be cut so as to ensure that both the 115 VAC primary pump and the 12 VDC backup pump rest flat on the floor of the sump basin when the plumbing is completely assembled and to align connection to the drain piping from the home. Dry-fit the assembly to confirm prior to gluing (see Figure 1).
 - Once dry-fit confirms that both pumps rest flat on the sump basin floor and the wye Assembly piping aligns with drain piping from the home, secure all connections by applying approved waterproof adhesive to all necessary joints and confirm that all flexible coupling hose clamps are fully engaged with plumbing and fully tightened.

Step 6

- a. Cable Ties (1) and (2) will be used to attach the 12 VDC pump control switch housing and power cord to the discharge pipe. Installing both cable ties to 12 VDC pump control switch is critical for proper operation of 12 VDC pump. (see Figure 1).
- b. Thread cable tie (1) through the eyelets on the 12 VDC pump control switch housing.
- c. Position the 12 VDC pump control switch on the discharge pipe such that cable tie (1) is 4" to 6" above the "ON" water level of the 115 VAC primary pump.
- d. Tighten cable tie (1) to secure the 12 VDC pump control switch to the discharge pipe.
- e. Install cable tie (2) around both the power cord of the 12 VDC pump control switch and the discharge pipe such that the power cord is securely routed away from any control floats.
- f. Use electrical tape to further secure the power cord of the 12 VDC pump control switch to the discharge pipe.

▲ NOTICE: RS-12 switch cord contains a breather tube. Be sure switch cord is not pinched so that breather tube is obstructed. Non-restrictive air flow in breather tube is required for proper RS-12 operation.

▲ NOTICE: For proper pump operation the exit point of all drain piping from the home must be lower, or sloping away, from the discharge plumbing's highest point. Improper water drainage can allow freezing within the line leading to system or component damage or failure.

▲ CAUTION Ensure all hose clamp connections and threaded connections are tight, and that all plumbing slip fit connections are properly glued prior to starting the sump pump system. Failure to do so can result in damage to pump system and/or cause property damage due to flooding.

▲ CAUTION Do not install or store the pump where it will be exposed to the weather or to temperatures below freezing or damage to the pump will occur.

Installation of a Backup System on a Separate Discharge

(For 12 VDC Backup Systems SPBS-10HF and SPBS-12HF which do not include a 115 V primary sump pump assembly)



WARNING Comply with all national and local electrical and plumbing codes when installing this unit. Disconnect power from all electrical equipment housed within the sump system before working on or around the sump pump or battery backup system beginning with 115 VAC powered pumps, level switches, and charger controllers; followed by DC powered items. Includes all items such as pumps, level control switches, Charger/Controller Unit, and battery systems.

Included in the SPBS-10 and SPBS-12 Kits:

1. Battery charger/controller
2. Battery case (battery not included)
3. (1) 1-1/2" 90° street elbow near 12 VDC pump
4. Flexible coupling from 12 VDC pump discharge
5. Check valve for 12 VDC pump
6. Switch to control 12 VDC pump
7. 12 VDC backup pump
8. (4) Cable ties

Customer required to purchase separately:

1. 12 VDC deep cycle battery – BCI Group 27, rated 85 – 140Ah, lead-acid or AGM
2. 115 VAC primary pump. Little Giant's 6EC-CIA-SFS or 10EC-CIA-SFS automatic pump is recommended
3. Check valve for 115 VAC pump
4. 1-1/2" pipe as needed
5. Fittings – As required

Figure 3

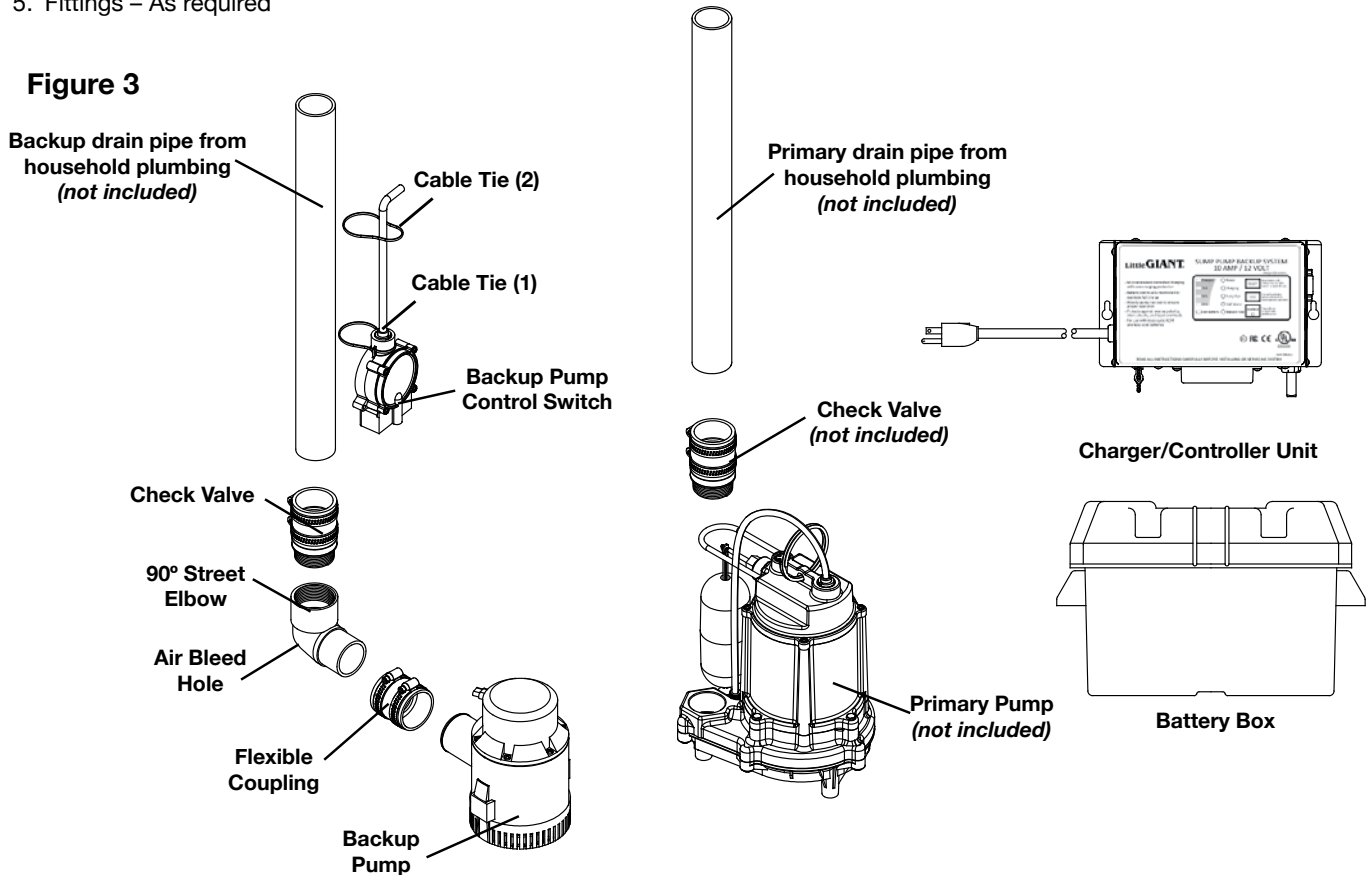

⚠ CAUTION Reduction of plumbing sizes from what is used for the discharges of the primary 115 VAC pump and 12 VDC pump can result in system under performance. Discharge piping that is of insufficient size can result in premature pump and/or system operation failure.

Figure 4

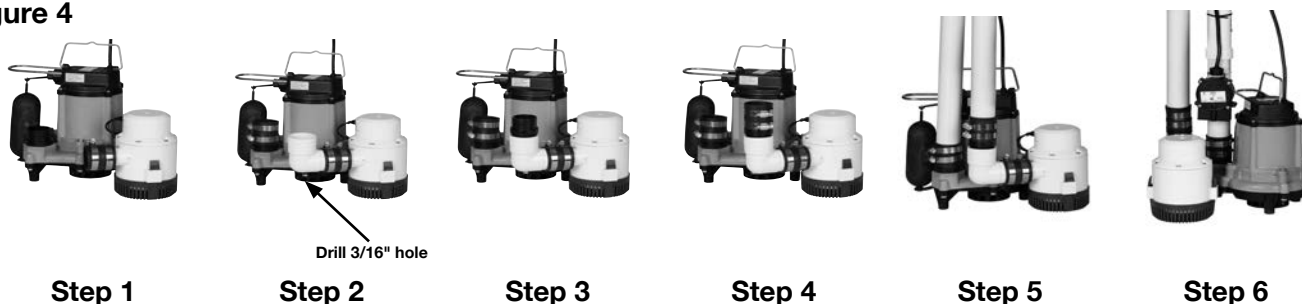

⚠ NOTICE: Do not glue any parts until the entire assembly, including primary pump, has been dry-assembled to verify fits. Fitting plumbing and routing wiring away from control floats will be much easier on a bench rather than working down inside a sump pit. (Fig. 4)

Step 1

- Install flexible coupling onto 12 VDC pump discharge.
- Position two hose clamps in the grooved recesses of flexible coupling installed on the 12 VDC pump.
- Tighten the flexible coupling's first hose clamp connection to securely fasten it to the 12 VDC pump discharge.
- Leave the hose clamp on the opposite end loose for the next plumbing piece.

Step 2

- A 3/16" diameter air bleed hole has been drilled in the 90° street elbow that is provided with the kit. (NOTICE: Air bleed hole must be located between the check valve and the 12 VDC pump to prevent the 12 VDC pump from air-locking.) The bleed hole is located so that the water flow through it will be at a downward angle to prevent splashing from the basin/pit.
- Slip 90° street elbow into the flexible coupling attached to the 12 VDC pump discharge, and tighten the hose clamp to secure elbow to the 12 VDC pump's discharge. (When properly installed the threaded elbow connection of the 90° street elbow should be facing straight up toward the top of the sump pit).

Step 3

⚠ NOTICE: A check valve is supplied and required for the backup pump's discharge plumbing. This check valve must be installed in the discharge plumbing between the backup pump and the connection joining the backup pump's discharge to the separate backup pump drain piping from the home.

- Apply PTFE tape to male threads of provided check valve.
- Thread PTFE taped end of check valve into 90° elbow.

Step 4

- Position two hose clamps in the grooved recesses of the flexible coupling on the check valve installed in the elbow.
- Tighten the lower hose clamp to secure the flexible coupling to the check valve body.
- Loosely tighten the upper hose clamp so it does not fall off. This clamp will be used to secure the check valve to the separate backup pump drain piping from the home.

Step 5

- Review the discharge plumbing of the 115 VAC primary pump.

⚠ NOTICE: A customer-supplied check valve is required in the discharge plumbing of the 115 VAC primary sump pump. This check valve must be installed in the discharge plumbing between the primary pump and the separate primary pump drain piping from the home. A 3/16" diameter air bleed hole must be located between the check valve and the 115 VAC pump to prevent the 115 VAC pump from air-locking. Locate the bleed hole so that the water flow through it will be at a downward angle to prevent splashing from the basin/pit.

- The 1-1/2" PVC pipe used in making the separate backup pump drain piping from the home must be cut so as to ensure that the 12 VDC backup pump rests flat on the floor of the sump basin when the plumbing is completed. Dry-fit the assembly to confirm prior to gluing (see Figure 4).
- Once dry-fit confirms that the 12 VDC backup pump rests flat on the sump basin floor and aligns with the separate backup pump drain piping from the home, secure all connections by applying approved waterproof adhesive to all necessary joints and confirm that all flexible coupling hose clamps are fully engaged with plumbing and fully tightened.

Step 6

- a. Cable ties (1) and (2) will be used to attach the 12 VDC pump control switch housing and power cord to the discharge pipe.
Installing both cable ties to 12 VDC pump control switch is critical for proper operation of 12 VDC pump. (See Figure 3).
- b. Thread cable tie (1) through the eyelets on the 12 VDC pump control switch housing.
- c. Position the 12 VDC pump control switch on the discharge pipe such that cable tie (1) is 4" to 6" above the "ON" water level of the 115 VAC primary pump.
- d. Tighten cable tie (1) to secure the 12 VDC pump control switch to the discharge pipe.
- e. Install Cable Tie (2) around both the power cord of the 12 VDC pump control switch and the discharge pipe such that the power cord is securely routed away from any control floats.
- f. Use electrical tape to further secure the power cord of the 12 VDC pump control switch to the discharge pipe.

▲ NOTICE: RS-12 switch cord contains a breather tube. Be sure switch cord is not pinched so that breather tube is obstructed. Non-restrictive air flow in breather tube is required for proper RS-12 operation.

▲ NOTICE: For proper pump operation the exit point of all drain piping from the home must be lower, or sloping away, from the discharge plumbing's highest point. Improper water drainage can allow freezing within the line leading to system or component damage or failure.

▲ CAUTION Ensure all hose clamp connections and threaded connections are tight, and that all plumbing slip fit connections are properly glued prior to starting the sump pump system. Failure to do so can result in damage to pump system and/or cause property damage due to flooding.

▲ CAUTION Do not install or store the pump where it will be exposed to the weather or to temperatures below freezing or damage to the pump will occur.

Installation of Pre-assembled Backup System on a Common Discharge

(For 12 VDC Backup Systems SPBS-10HF-6 and SPBS-12HF-10 with included 115 VAC Primary Pump)



WARNING Comply with all national and local electrical and plumbing codes when installing this unit. Disconnect power from all electrical equipment housed within the sump system before working on or around the sump pump or battery backup system beginning with 115 VAC powered pumps, level switches, and charger controllers; followed by DC powered items. Includes all items such as pumps, level control switches, Charger/Controller Unit, and battery systems.

CAUTION Reduction of plumbing sizes from what is used for the discharges of the primary 115 V and 12 VDC can result in system under performance. Discharge piping that is of insufficient size can result in premature pump and/or system operation failure.

Included in the SPBS-10HF-6 and SPBS-12HF-10 kits: **Figure 5**

1. 12 VDC backup pump
2. 115 VAC primary pump
3. Battery charger/controller
4. Battery case (battery not included)
5. (1) 1-1/2" street elbow near 12 VDC pump
6. Coupling for 12 VDC pump discharge
7. Check valve for 12 VDC pump
8. Switch to control 12 VDC pump
9. Check valve for 115 VAC pump
10. Discharge pipe "wye" assembly connected to the 12 VDC pump and 115 VAC pump

Figure 5
Pre-assembled with Common Discharge Pipe "WYE" Assembly

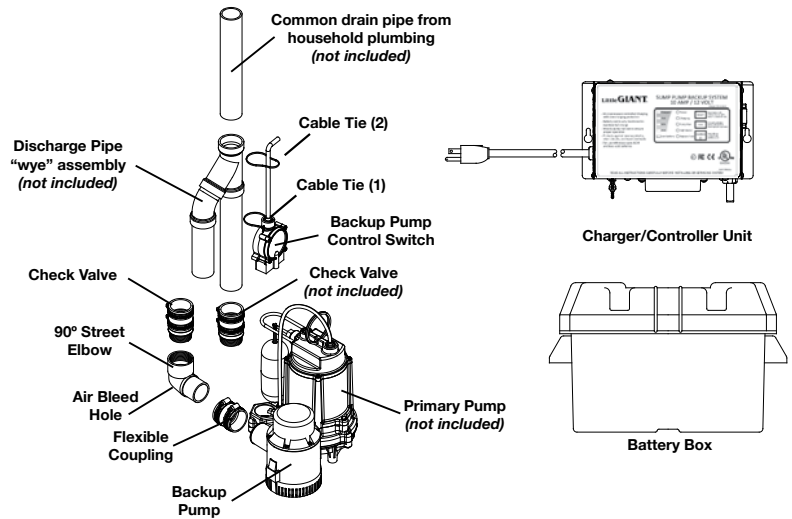

Customer required to purchase separately:

1. 12 VDC deep cycle battery – BCI Group 27, rated 85 – 140Ah, Lead-acid or AGM
2. Pipe and coupling or check valve (For connection to drain pipe from household plumbing to discharge pipe "wye" assembly)
3. Waterproof adhesive for plumbing connections

Step 1

- a. Remove all debris from the sump basin.
- b. Confirm that all flexible couplings and hose clamps are properly seated and tight on the PVC plumbing discharge piping that is part of the sump pump backup system.
- c. Place the sump pump backup system into the sump pit/basin. Support both pumps as the assembly is lowered into the basin. Do not use the PVC plumbing as a handle during this process as the connections might come loose.
- d. The connection from the discharge pipe "wye" assembly to the drain piping from the home must be made so as to ensure that both the 115 VAC primary pump and the 12 VDC backup pump rest flat on the floor of the sump basin when the plumbing is completely assembled and to align connection to the drain piping from the home. Dry-fit the assembly to confirm prior to gluing (see Figure 5).
- e. Once dry-fit confirms that both pumps rest flat on the sump basin floor and the wye assembly piping aligns with drain piping from the home, secure all connections by applying approved waterproof adhesive to all necessary joints and confirm that all flexible coupling hose clamps are fully engaged with plumbing and fully tightened.

CAUTION For proper pump operation the exit point of all drain piping from the home must be lower or sloping away, from the discharge plumbing's highest point. Improper water drainage can allow freezing within the line leading to system or component damage or failure.

CAUTION Ensure all hose clamp connections and threaded connections are tight and that all plumbing slip fit connections are properly glued prior to starting the sump pump system. Failure to do so can result in damage to pump system and/or cause property damage due to flooding.

CAUTION Do not install or store the pump where it will be exposed to the weather or to temperatures below freezing or damage to the pump will occur.

Charger/Controller Unit Installation

Little GIANT

SUMP PUMP BACKUP SYSTEM 10 AMP / 12 VOLT

Charger P/N 1210HF

- Microprocessor controlled charging with overcharging protection
- Battery continually monitored to maintain full charge
- Weekly pump run test to ensure proper operation
- Protects against reverse polarity, short circuits, and input overloads
- For use with deep cycle AGM and lead-acid batteries

<input type="checkbox"/> Charged	<input type="radio"/> Power	<input type="button" value="RESET"/>	Reset button will reset pump run light. System is ready for use.
<input type="checkbox"/> 75%	<input type="radio"/> Charging	<input type="button" value="TEST"/>	Manually activates pump and alarm to ensure proper operation
<input type="checkbox"/> 50%	<input type="radio"/> Pump Run	<input type="button" value="SILENCE"/>	Press silence to deactivate audible alarm
<input type="checkbox"/> 25%	<input type="radio"/> High Water		
<input type="checkbox"/> Low Battery	<input type="radio"/> Replace Fuse		



E302556

Form 986335

READ ALL INSTRUCTIONS CAREFULLY BEFORE INSTALLING OR SERVICING SYSTEM

Charger/Controller Electrical Ratings:

Input: 120 VAC, 3 Amp

Output (Maximum Charging Current):

- Model 1210HF: 12 VDC, 10 Amps
- Model 1212HF: 12VDC, 12 Amps

Use only with 12 VDC deep cycle battery rated 85 – 140Ah, lead-acid or AGM

⚠ WARNING Do not use in explosive atmospheres. Do not handle Charger/Controller Unit with wet hands or when standing on a wet or damp surface, or in water.

⚠ WARNING To reduce risk of electric shock which can result in personal injury, death or major property damage if ignored, be certain that the 115 VAC pump and the Charger/Controller Unit are connected to outlets protected by ground fault circuit interrupters (GFCI). Comply with all national and local electrical and plumbing codes when installing this unit. Do not use the same 115 VAC outlet for primary pump and Battery Charger/Controller Unit. Do not use extension cord.

⚠ WARNING A spark near the battery may cause an explosion. Always unplug Charger/Controller Unit prior to making connections to or disconnections from the battery. Take care to prevent accidental shorting across battery terminals during handling. Do not leave battery uncovered. Attach or strap cover securely on battery box when completing installation.

⚠ CAUTION The battery required to operate this unit contains acid and proper precautions must be taken when handling. Refer to battery manufacturer's safety guidelines. Failure to use proper personal protective equipment or electrical caution can result in hazards that will or can cause personal injury or major property damage if ignored.

⚠ CAUTION If a Carbon Monoxide (CO) sensor is installed near the battery backup system, battery, or Charger/Controller Unit, nuisance or false alarms could result. CO detectors should be a minimum of 15 feet from the systems. Refer to the manufacturer of CO detector for additional instructions or information.

⚠ CAUTION The backup pump relies on a sufficiently charged battery to operate the pump. The charger is designed to charge the battery and maintain charge level when the backup pump is not in use.

⚠ NOTICE: The Charger/Controller Unit emits an audible alarm when running the 12 VDC backup pump. An additional (not supplied in this kit) audible high water alarm on the sump system is recommended in any installations where property damage and/or personal injury might result from an inoperative sump system due to long term power outages, discharge line blockage, or any other reason.

Charger/Controller Unit Installation (continued)

Step 1 – Mounting the Charger/Controller Unit

▲ NOTICE: Do not expose the charger to excessive moisture. Install charger in a dry location. Indoor use only.

- Complete all plumbing, pump installation and pump control switch installation before installing the Charger/Controller Unit and before beginning work on the electrical connections to the Charger/Controller Unit or the battery.
- Charger/Controller Unit is designed to be installed on the wall in a visible location. The LED lights on the front of the charger as well as the switches on the face of the unit should be accessible and clearly visible.
- Select a location for the Charger/Controller Unit and the battery relative to the sump basin such that all the provided wiring will reach their respective connections with some slack remaining in the wiring. Locate the Charger/Controller Unit as far away from battery as the provided wiring permits. Charger/Controller Unit should not be installed directly over the battery. Gases from the battery will corrode and damage the Charger/Controller Unit. Battery should be positioned away from the wall to allow adequate ventilation of any fumes that are given off during charging.
- Use the Charger/Controller Unit's mounting holes to mark location on the wall for the included anchors and mounting screws.
- Install the Charger/Controller Unit on the wall using the included anchors and mounting screws, if suitable. Installer to confirm suitability of the mounting surface, method, and hardware.

▲ CAUTION The long ribs on the Charger/Controller Unit should be on top and the cords exit downward when the Charger/Controller Unit is installed on the wall. The long ribs are heat sinks and may become hot in normal operation. Do not allow these surfaces to become covered in combustible materials and do not touch these during normal operation. All combustible materials should be kept away from the hot surfaces of the Charger/Controller Unit, and the Charger/Controller Unit should be well away from other sources of heat such as space heaters, radiators, boilers, furnace etc.

▲ CAUTION The Charger/Controller Unit has a 115 VAC power supply cord, a cord for connecting to the battery, and a cord for connecting to the pump cord. If any of the cords are damaged, or the Charger/Controller Unit itself becomes damaged, immediately un-plug the Charger/Controller Unit and remove it from service. Always disconnect 115 VAC power supply cord before doing any service of the product and allow the Charger/Controller Unit to cool. Disconnect 115 VAC before disconnecting battery leads.

▲ CAUTION Power is being supplied to the 12 VDC backup pump when the “Water High” indicator is on or the test button is held down. Do not disconnect the pump cable while power is going to the 12 VDC backup pump.

▲ CAUTION There are no serviceable parts inside the Charger/Controller Unit body. Do not open or attempt any repairs inside the Charger/Controller Unit body. Hazardous voltage exists inside the enclosure.

▲ CAUTION Do not try to charge non rechargeable batteries.

▲ NOTICE: 12 VDC backup pump fuse is located on the bottom of the charger. Replacement fuse should be automotive type 32 V, 20A type ATC.

Figure 6

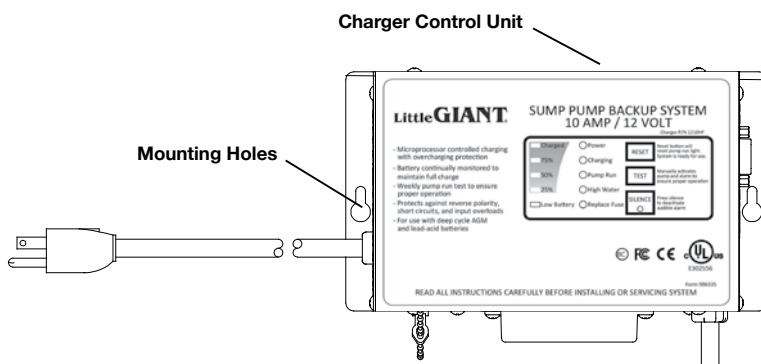
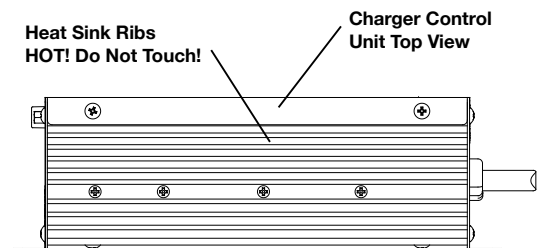

Figure 7



Charger/Controller Unit Installation (continued)

Step 2 – Electrical Connections



WARNING Comply with all national and local electrical and plumbing codes when installing this unit. Disconnect power from all electrical equipment housed within the sump system before working on or around the sump pump or battery backup system beginning with 115 VAC powered pumps, level switches, and charger controllers; followed by DC powered items. Includes all items such as pumps, level control switches, Charger/Controller Unit, and battery systems.

NOTICE: Installation of the 115 VAC electrical supply circuit to the battery charger is to be done by a certified licensed electrician in accordance with national and local codes.

- Verify that Charger/Controller Unit is not connected to power supply source. Remove plastic cover on the bottom of Charger Controller Unit. Connect the terminals from the control switch cord to the (2) male tab terminals on the Charger/Controller Unit marked "SWITCH". Reinstall plastic cover.
- Verify that all plumbing is complete per instructions.
- Connect the terminals from the backup pump cord to the terminals from the Charger/Controller Unit cord for the pump being careful to match the correct polarity.
- Connect Charger/Controller Unit to the battery. Be certain to connect positive terminal of the Charger/Controller Unit cord for the battery to the positive post of the battery. Correct polarity is marked on the cord as well as the battery. In case of reverse connection the Charger/Controller Unit will sound an alarm when 115 VAC power is supplied to the Charger/Controller Unit.
- Do not connect this Charger/Controller Unit to the same circuit as is used for the primary pump. The AC outlet used for the Charger/Controller Unit requires separate 3A, 115 VAC circuit.
- Verify that all wiring is per instructions. Once all plumbing and electrical connections are complete and verified, plug 115 VAC power supply cord for the Charger/Controller Unit into a 115 VAC electrical outlet.
- Press the "test switch" and observe that the 12 VDC pump is running.
- Review Charger/Controller Operation section.
- Perform testing per the Sump System Operation Testing Section.

NOTICE: The Charger/Controller Unit has provisions for connection to auxiliary Class 2 alarm system or phone dialer (not included). This circuit is normally open and closes when the 12 VDC pump switch circuit closes. Once closed, the circuit remains closed until "RESET" button is pushed on the Charger/Controller Unit. This circuit requires Class 2 wiring. If used, route this wiring away from the Charger/Controller Unit power supply cord, battery cord, and pump cord. Follow manufacturer's instructions for dialer or alarm system.

Charger/Controller Unit Electrical Connections

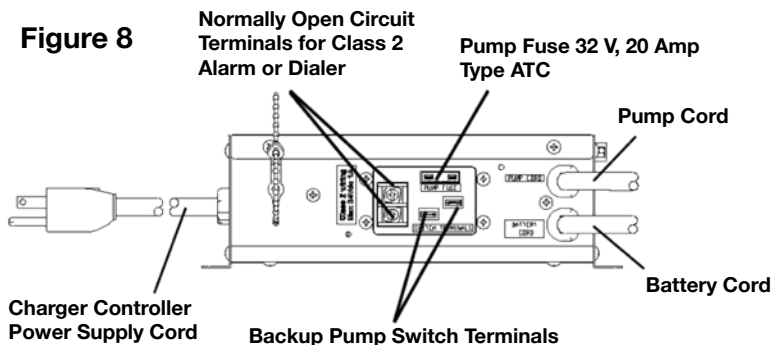

Wiring Diagram

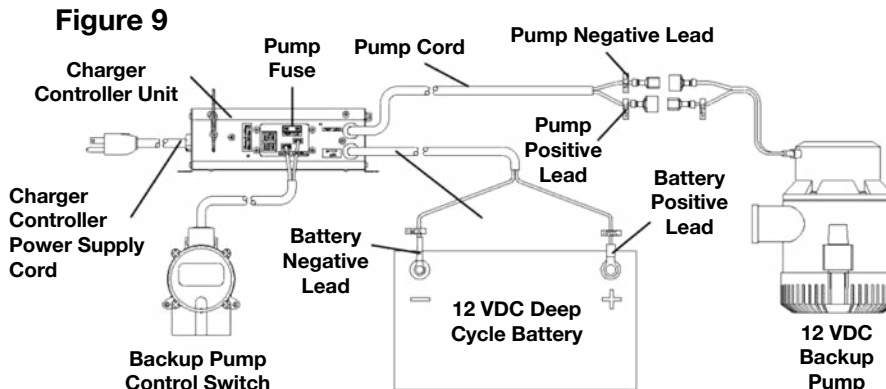

Charger/Controller Unit Operation

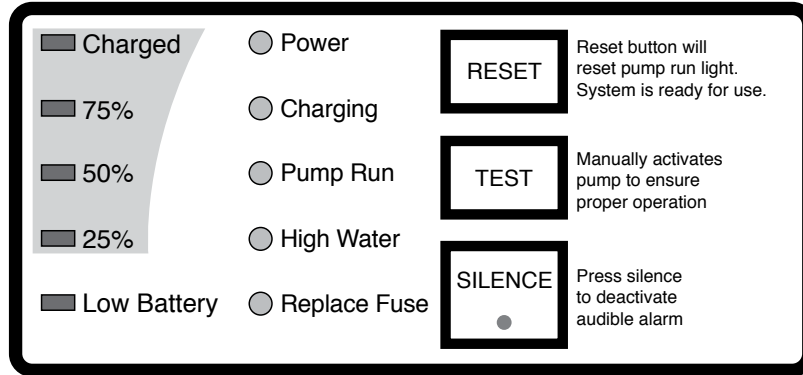

Figure 10

1. The upper left side of the face plate provides an approximation of the battery charge. In normal operation the charge will typically show 25%, 50%, and 75% lights lit. When these are lit the system is indicating the approximate power available to the pump. A maintenance charge to the battery is happening between “75% and Charged” which means the charger is maintaining the maximum capacity the battery is capable of producing when “75% and Charged” indicators are lit.
2. The green “Charging” indicator is lit when the battery is charging. When the “Low Battery” indicator is lit the 12 VDC backup pump will not function properly. A new fully charged 90AH deep cycle battery will allow the 12 VDC backup pump to operate for about 1 day assuming that the pump has a cycle of 1 minute on and 4 minutes off. The time you have will depend upon the age of the battery, the charge in the battery, and how often the 12 VDC pump must run. An older battery will provide less time. The 115 VAC primary pump must be made operational in the time you have before the “Low Battery” light comes on. For the battery to begin recharging, 12 VDC pump must not be drawing power from the battery. A fully discharged 90AH battery requires approximately 9 hours to fully charge. Batteries must be re-charged soon after being discharged or possible damage to the battery will occur.
3. The red “Power” indicator will come on when the 115 VAC plug is plugged into power and power is available. If no power is available then the light does not light and the charger will not charge the battery.
4. The “Pump Run” indicator comes on when the switch that controls the battery backup pump first activates. The indicator will remain on until “RESET” button is pushed.
5. The “High Water” indicator comes on when the pump is actively trying to remove water from the sump. The switch for the 12 VDC pump is in the on position and providing power to the 12 VDC pump when lit. When switch is in off position the indicator is off and no power is going to the pump.
6. The “Fuse” indicator is lit when the Fuse has failed. Replace with automotive type 32 V, 20A type ATC fuse, on the bottom of the charger.
7. The “RESET” switch will reset the system if the switch is no longer activated. System will then check to verify everything is normal and if so, system re-sets. If any problems such as switch still activated, this indicator will again be lit, the audible alarm will sound and the battery status will be verified.
8. The “Test” button allows you to manually verify that pump operates without having to activate the switch. Press and hold the button and you should hear the pump operating.
9. The “Silence” button turns off the audible alarm.

ITEM	FUNCTION	DESCRIPTION / OPERATIONS
Charged – 75%	LED Indicators	Indicates battery is between 75% and Fully Charged. Charger is in maintenance mode to maintain highest battery capacity possible.
50%	LED Indicator	Indicates the battery level based on a voltage level
25%	LED Indicator	Indicates the battery level based on a voltage level
Low Battery	LED Indicator	Indicates battery is critically discharged, pump will not work
Power	LED Indicator	Indicates AC power is present
Charging	LED Indicator	Indicates battery is receiving current from the charger
Pump Run	LED Indicator	Indicates the pump ran and system has not been re-set
High Water	LED Indicator	Indicates the switch contact is closed
Replace Fuse	LED Indicator	Indicates the pump circuit has no power & 20A fuse must be replaced
RESET	Button/Key	This switch will reset system
TEST	Button/Key	Depress & hold this switch allows you manually test 12 VDC pump.
SILENCE	Button/Key	This switch turns off the buzzer and a yellow silence indicator comes on

Sump System Operation Testing

⚠ WARNING Always disconnect the electrical power before touching the pump or discharge when water is present in the area of the pump. Failure to do so can result in hazardous electrical shock.

⚠ CAUTION Ensure all hose clamp connections and threaded connections are tight and that all plumbing slip fit connections are properly glued prior to starting the sump pump system. Failure to do so can result in damage to pump system and/or cause property damage due to flooding.

⚠ CAUTION Do not allow the pump to run dry or damage to the pump will occur. Do not allow the sump basin to overflow during this testing.

Step 1

- a. Verify that all wiring is per instructions and that primary pump and controller are connected to power.
 - i. The red "Power" indicator light should be lit on the Charger/Controller Unit.

Step 2

- a. Run water into the sump basin until the primary pump is activated.
 - i. Do not attempt to run the pump without water; this could result in permanent damage to the pump.
 - ii. Confirm that primary pump and its control switch are functioning as intended.
 - iii. Confirm that ON-OFF levels are within specification and confirm that no potential obstructions exist that could inhibit switch operation.
 - iv. Confirm that there are no leaks in the primary pump discharge plumbing and main home drain pipe plumbing.
 - a) It is normal for a stream of water to spray from the air bleed hole in the primary pump's plumbing. Confirm that this spray is captured within the sump basin.

Step 3

- a. After primary pump function has been confirmed, disconnect power to primary pump.
 - i. This is typically done at an electrical connection box or a plug receptacle.

Step 4

- a. Run water into the sump basin until the backup pump is activated.
 - i. Do not attempt to run the pump without water; this could result in permanent damage to the pump.
 - ii. Confirm that backup pump and its control switch are functioning as intended.
 - iii. Confirm that the Charger/Controller Unit emits an audible alarm when running the backup pump.
 - a) Press SILENCE button on the Charger/Controller Unit to silence the audible alarm.
 - iv. Confirm that ON-OFF levels are within specification and confirm that no potential obstructions exist that could inhibit switch operation.
 - a) The RS-12 switch will activate the 12 VDC backup pump when water is approximately 6 inches above the bottom of the RS-12 switch.
 - v. Confirm that there are no leaks in the backup pump discharge plumbing and main home drain pipe plumbing.
 - a) It is normal for a stream of water to spray from the air bleed hole in the backup pump's plumbing. Confirm that this spray is captured within the sump basin.

Step 5

- a. After backup pump function has been confirmed, disconnect power to the Charger/Controller Unit to confirm proper battery function.
 - i. This is typically done at an electrical connection box or a plug receptacle.

Step 6

- a. Run water into the sump basin until the backup pump is activated.
 - i. Confirm that backup pump and its control switch are functioning as intended.
 - ii. Confirm that the Charger/Controller Unit emits an audible alarm when running the backup pump.
 - a) Press SILENCE button on the Charger/Controller Unit to silence the audible alarm.

Step 7

- a. After primary pump, backup pump and Charger/Controller Unit function has been confirmed, reconnect power to the Charger/Controller Unit and the primary pump
 - i. Confirm that primary pump activates and evacuate the remaining water from the sump basin down to the normal OFF level of the primary pump. Primary pump should deactivate when the OFF level is reached.

Step 8

- a. Charger/Controller Unit faceplate indicators should provide status of battery's charge.
 - i. See Charger/Controller Unit Operation section for details.

Step 9

- a. Confirm that battery is in working condition according to the battery manufacturer's instructions and is fully charged.

Step 10

- a. The primary and backup pumps are now ready for operation.

System Maintenance:



⚠ WARNING Disconnect power from all electrical equipment housed within the sump system before working on or around the sump pump or battery backup system beginning with 115 VAC powered pumps, level switches, and charger controllers; followed by DC powered items. Includes all items such as pumps, level control switches, Charger/Controller Unit, and battery systems.

⚠ CAUTION The backup pump and the primary pump are designed for pumping clear water only. Do not use the pumps in applications where effluent (grey water), sewage or any other debris (gravel, sand, floating debris, etc.) is present.

⚠ CAUTION Do not allow the sump basin to overflow during this maintenance.

⚠ NOTICE: Inspect and test the sump system condition and operation every 3 months (more frequently in heavy use applications).

Step 1

- a. Refer to battery manufacturer's instructions to confirm that battery is in working condition and is fully charged.
 - i. Clean any corrosion from the battery posts or pump terminals.

Step 2

- a. Remove all debris (gravel, sand, floating debris, etc.) from the sump basin.
- b. Review sump system components for any build-up (minerals, etc.) that would inhibit functionality of the components.
 - i. If significant, remove build-up or replace affected components.

Step 3

- a. Confirm that all flexible coupling hose clamps are fully engaged with plumbing and fully tightened.

Step 4

- a. Test operation of the sump system following the instructions outlined in the Sump System Operation Testing section of this manual.

Troubleshooting

TROUBLESHOOTING INFORMATION

PROBLEM	PROBABLE CAUSES	115 V	12 V	CORRECTIVE ACTION
Pump does not turn on or turn off.	Bad connection	X	X	Plug-in pump
	Blown fuse		X	Turn on circuit breaker or replace fuse
	Bad battery		X	Replace battery
	Pump impeller obstructed	X	X	Pull pump and clean
	Pump control switch	X	X	Replace switch
Pump does not deliver rated capacity.	Low battery		X	When power is restored, the charger will charge the battery
	Check valve installed backwards	X	X	Check flow indication arrow on check valve body to ensure it is installed properly
	Low voltage, speed too slow	X	X	Check for proper supply voltage to make certain it corresponds to name plate voltage.
	Impeller or discharge pipe is clogged	X	X	Pull pump and clean. Check pipe for scale or corrosion
Pump cycles continually.	Defective battery		X	Replace battery
	No check valve in long discharge pipe allowing liquid to drain back into sump.	X	X	Install a check valve in discharge line
	Check valve leaking	X	X	Inspect check valve for correct operation
	Sump pit too small for inflow	X	X	Install larger sump pit
Pump will not shut off. NOTE: Before troubleshooting automatic control, check to see that pump operates on manual control. To do this, create slight vacuum on breather tube (near plug), then close off tube with thumb, plug into wall outlet. If pump works, proceed to check switch; if not, fault is in pump or power supply.	Pump control switch	X	X	Replace switch
	Plugged vent tube		X	Clear vent tube of any obstruction
	Dirt or sediment lodged between retainer ring and rubber diaphragm causing contacts to remain closed		X	Clean area around rubber diaphragm
	Pump is air locked	X	X	Shut power off for approximately 1 minute, then restart. Repeat several times to clear air from pump. If system includes a check valve, a 3/16" hole should be drilled in the discharge pipe between the pump discharge and the check valve.
	Liquid inflow matches pump capacity	X	X	Larger pump required
Pump runs but does not discharge liquid.	Check valve installed backwards	X	X	Check flow indicating arrow on check valve body to ensure it is installed properly.
	Check valve stuck or plugged	X	X	Remove check valve and inspect for proper operation
	Lift too high for pump	X	X	Check pump performance as compared to the vertical distance needed to evacuate the sump water
	Inlet to impeller plugged	X	X	Pull pump and clean
	Pump is air locked	X	X	Shut power off for approximately 1 minute, then restart. Repeat several times to clear air from pump. If system includes a check valve, a 3/16" hole should be drilled in the discharge pipe between the pump discharge and the check valve.

LIMITED WARRANTY

THIS WARRANTY SETS FORTH THE COMPANY'S SOLE OBLIGATION AND PURCHASER'S EXCLUSIVE REMEDY FOR DEFECTIVE PRODUCT.

Franklin Electric Company, Inc. and its subsidiaries (hereafter "the Company") warrants that the products accompanied by this warranty are free from defects in materials or workmanship of the Company that exist at the time of sale by the Company and which occur or exist within the applicable warranty period. Any distributor, sub-distributor, recipient, end-user and/or consumer agrees that by accepting the receipt of the products, the distributor, sub-distributor, recipient, end user and/or consumer expressly agree to be bound by the terms of the warranty set forth herein.

I. Applicable Warranty Period

The products accompanied by this warranty shall be covered by this Limited Warranty for a period of 24 months from the date of original purchase by the consumer. In the absence of suitable proof of purchase date, the warranty period of this product will begin to run on the product's date of manufacture.

II. Instructions Applicable to this Limited Warranty

1. Consumers wishing to submit a warranty claim must return the products accompanied by this warranty to the point of purchase for warranty consideration.
2. Upon discovery of a defect, any personal injury, property damage or any other type of resulting damage, if applicable, shall be reasonably mitigated to the extent possible.
3. At its discretion, the Company may inspect products either at its facilities or in the field, and after determination of a warranty claim, will, at its option, repair or replace defective parts. Repaired or replaced parts will be returned freight prepaid by the Company.
4. This warranty policy does not cover any labor or shipping charges. The Company shall not be liable for any costs or charges attributable to any product testing, maintenance, installation, repair or removal, or for any tools, supplies, or equipment needed to install, repair, or remove any product.

III. Limitations Applicable to this Limited Warranty

THIS WARRANTY DOES NOT APPLY TO ANY OF THE FOLLOWING:

1. Any product that is not installed, applied, maintained, and used in accordance with the Company's published instructions, applicable codes, applicable ordinances and/or with generally accepted industry standards.
2. Any product that has been subject to misuse, misapplication, neglect, alteration, accident, abuse, tampering, acts of God (including lightning), acts of terrorism, acts of war, fire, improper storage or installation, improper use, improper maintenance or repair, damage or casualty, or to an excess of the recommended maximums as set forth in the product instructions.
3. Any product that is operated with any accessory, equipment, component, or part not specifically approved by the Company.
4. Use of replacement parts not sold by the Company, the unauthorized addition of non-Company products to other Company products, and the unauthorized alteration of Company products.
5. Products damaged by normal wear and tear, normal maintenance services and the parts used in connection with such service, or any other conditions beyond the control of the Company.
6. Any product that has been used for purposes other than those for which it was designed and manufactured.
7. Any use of the product where installation instructions and/or instructions for use were not followed.

The Company reserves the right at any time, and from time to time, to make changes in the design and/or improvements upon its product without thereby imposing any obligation upon itself to make corresponding changes or improvements in or upon its products already manufactured and/or previously sold. The Company further reserves the right to substitute parts or components of substantially equal quality in any warranty service required by operation of this Limited Warranty.

This written Limited Warranty is the entire warranty authorized and offered by the Company. There are no warranties or representations beyond those expressed in this document.

THIS WARRANTY AND REMEDY IS IN LIEU OF ALL OTHER WARRANTIES AND REMEDIES INCLUDING, WITHOUT LIMITATION,

WARRANTIES OF MERCHANTABILITY AND/OR FITNESS FOR A PARTICULAR PURPOSE, WHICH ARE HEREBY SPECIFICALLY DISCLAIMED AND EXPRESSLY EXCLUDED. CORRECTION OF NON-CONFORMITIES, IN THE MANNER AND FOR THE PERIOD OF TIME AS SET FORTH ABOVE, SHALL CONSTITUTE FULFILLMENT OF ALL LIABILITY OF THE COMPANY TO THE PURCHASER WHETHER BASED ON CONTRACT, NEGLIGENCE, OR OTHERWISE.

THE COMPANY SHALL NOT BE LIABLE FOR INCIDENTAL, CONSEQUENTIAL OR SPECIAL DAMAGES SUCH AS, BUT NOT LIMITED TO:

DAMAGE TO OR LOSS OF OTHER PROPERTY OR EQUIPMENT, LOSS OF USE OF EQUIPMENT, FACILITIES OR SERVICE, LOSS OF PROFIT OR SALES, COST OF PURCHASES OR REPLACEMENT GOODS, CLAIMS OF CUSTOMERS OF THE PURCHASER, FAILURE TO WARN AND/OR INSTRUCT, LOSS OF OTHER PRODUCTS, OR COSTS OF ENVIRONMENTAL REMEDIATION, OR DIMINUTION IN PROPERTY VALUE. THE REMEDIES OF THE PURCHASER SET FORTH HEREIN ARE EXCLUSIVE, AND THE LIABILITY OF THE COMPANY SHALL NOT, EXCEPT AS EXPRESSLY PROVIDED HEREIN, EXCEED THE PRICE OF THE PRODUCTS UPON WHICH SUCH LIABILITY IS BASED. DAMAGES AS SET FORTH IN THIS PARAGRAPH SHALL BE REASONABLY MITIGATED TO THE EXTENT POSSIBLE. THIS PARAGRAPH SHALL ALSO APPLY TO ALL DAMAGES RESULTING FROM CONDITIONS SET FORTH IN SECTION III ABOVE AND (1) DEFECTS IN PRODUCT PROTOTYPES OR REPLACEMENT PART PROTOTYPES THAT HAVE NOT BEEN PUT INTO PRODUCTION, CIRCULATED AND SOLD BY THE COMPANY, AND/OR (2) DEFECTS THAT WERE NOT FOUND AT THE TIME OF SALE DUE TO SCIENTIFIC AND TECHNOLOGICAL REASONS.

This Limited Warranty gives you specific legal rights. You may have other rights, which vary according to the applicable laws and regulations. Where any term of this warranty is prohibited by such laws, it shall be null and void, but the remainder of this warranty shall remain in full force and effect.

DISCLAIMER: Any oral statements about the product made by the seller, the Company, the representatives or any other parties, do not constitute warranties, shall not be relied upon by the user, and are not part of the contract for sale. Seller's and the Company's only obligation, and buyer's only remedy, shall be the replacement and/or repair by the Company of the product as described above. Before using, the user shall determine the suitability of the product for his intended use, and user assumes all risk and liability whatsoever in connection therewith.

For technical assistance, please contact 800.701.7894

www.littlegiant.com
lgnet@fele.com



Form 998912
Rev. 0
08.15

LittleGIANT[®]

Franklin Electric Co., Inc.
Oklahoma City, OK 73157-2010
Phone: 1.800.701.7894
Fax: 1.405.228.1561